

# CLIFFORD®

## Responder LC Model 50.7X Security and Remote Start Installation Guide

This product is intended for installation by a professional installer only! Attempts to install this product by a person other than a trained professional may result in severe damage to a vehicle's electrical system and components.

***Directed***®  
E L E C T R O N I C S

© 2008 Directed Electronics, Vista, CA  
N5702X 2008-08

Bitwriter®, Code Hopping™, Doubleguard®, ESP™, FailSafe®, Ghost Switch™, Learn Routine™, Nite-Lite®, Nuisance Prevention® Circuitry, Revenger®, Silent Mode™, Soft Chirp®, Stinger®, Valet®, Vehicle Recovery System®, VRS®, and Warn Away® are all Trademarks or Registered Trademarks of Directed Electronics.



The Bitwriter® (p/n 998U) requires chip version 2.6 or newer to program this unit.

Bitwriters with a date code of 6a or older require an IC upgrade (p/n 998M). Some bitwriters with a date code of 6B do not require the IC upgrade, refer to tech tip # 1112 for more information. Bitwriter 2 compatible.



# Contents

---

Warning! safety first .....	5
What is included .....	7
Installation points to remember .....	7
Virtual Tach .....	7
The control center .....	8
Valet® program switch .....	8
Status LED .....	8
Doubleguard shock sensor .....	9
Before beginning the installation .....	9
After the installation .....	9
Component locations and finding wires .....	10
Making your wiring connections .....	10
Primary harness (H1), 12-pin connector .....	11
Auxiliary harness (H2), 8-pin connector .....	11
Heavy gauge remote start, (H3) 10-pin connector .....	12
Remote start input, 5-pin connector .....	12
Remote start auxiliary output, 5-pin .....	12
Door lock harness, 3-pin connector .....	13
Wire connection guides .....	14
Primary harness (H1) .....	14
Auxiliary harness (H2) .....	18
Heavy Gauge, 10-pin connector .....	22
Remote start input - 5-pin connector .....	24
Door lock wire diagrams .....	26
Neutral safety switch interface .....	27
Testing the neutral safety switch .....	27
Plug-in LED and valet/program switch .....	28
Bitwriter interface - 3-pin black plug .....	28
Optional sensor port - 4-pin connector .....	28
Tachometer settings .....	29
Virtual tach .....	29
Tach learning .....	30
Tach threshold On/Off .....	30
D2D Jumper settings .....	31
Setting the light flash polarity .....	31
Impact Sensor Adjustment .....	32
Remote control Learn Routine™ .....	34
Remote Control Programming .....	34
Remote control configuration .....	37
Responder LC 2-way .....	37
System features learn routine .....	38
Feature menus .....	41

Menu 1 - Security.....	41
Menu 2 - Convenience .....	42
Menu 3 - Remote start .....	43
Feature descriptions.....	44
Menu 1 - Security.....	44
Menu 2 - Convenience .....	47
Menu 3 - Remote start .....	49
Bitwriter® .....	53
Long term event history .....	55
Table of zones .....	56
Shutdown diagnostics.....	56
Remote starting diagnostics .....	57
Remote start safety check .....	58
Troubleshooting .....	59
Alarm .....	59
Remote start .....	60



## Warning! safety first

---

The following safety warnings must be observed at all times:

- Due to the complexity of this system, installation of this product must only be performed by an authorized Directed Electronics dealer.
- When properly installed, this system can start the vehicle via a command signal from the remote control. Therefore, never operate the system in an area that does not have adequate ventilation.

The following precautions are the sole responsibility of the user; however, authorized Directed Electronics dealers should:

- **Never use a test light or logic probe when installing this unit. Always use a multimeter.**
- Never operate the system in an enclosed or partially enclosed area without ventilation (such as a garage).
- When parking in an enclosed or partially enclosed area or when having the vehicle serviced, the remote start system must be disabled using the installed toggle switch. It is the user's sole responsibility to properly handle and keep out of reach from children all remote controls to assure that the system does not unintentionally remote start the vehicle.
- **USER MUST INSTALL A CARBON MONOXIDE DETECTOR IN OR ABOUT THE LIVING AREA ADJACENT TO THE VEHICLE. ALL DOORS LEADING FROM ADJACENT LIVING AREAS TO THE ENCLOSED OR PARTIALLY ENCLOSED VEHICLE STORAGE AREA MUST REMAIN CLOSED AT ALL TIMES.**

Use of this product in a manner contrary to its intended mode of operation may result in property damage, personal injury, or death. Except when performing the Safety Check outlined in this installation guide, (1) Never remotely start the vehicle with the vehicle in gear, and (2) Never remotely start the vehicle with the keys in the ignition. The user is responsible for having the neutral safety feature of the vehicle periodically checked, wherein the vehicle must not remotely start while the car is in gear. This testing should be performed by an authorized Directed Electronics dealer in accordance with the Safety Check outlined in this product installation guide. If the vehicle starts in gear, cease remote start operation immediately and consult with the user to fix the problem immediately.

After the remote start module has been installed, test the remote start module in accordance with the Safety Check outlined in this installation guide. If the vehicle starts when performing the Neutral Safety Shutdown Circuit test, the remote start unit has not been properly installed. The remote start module must be removed or properly reinstalled so that the vehicle does not start in gear. All installations must be performed by an authorized Directed Electronics dealer.

OPERATION OF THE REMOTE START MODULE IF THE VEHICLE STARTS IN GEAR IS CONTRARY TO ITS INTENDED MODE OF OPERATION. OPERATING THE REMOTE START SYSTEM UNDER THESE CONDITIONS MAY RESULT IN PROPERTY DAMAGE OR PERSONAL INJURY. IMMEDIATELY CEASE THE USE OF THE UNIT AND REPAIR OR DISCONNECT THE INSTALLED REMOTE START MODULE. DIRECTED ELECTRONICS WILL NOT BE HELD RESPONSIBLE OR PAY FOR INSTALLATION OR REINSTALLATION COSTS.

Remote starters for manual transmission pose significant risks if not properly installed and operated. When testing to ensure the installation is working properly, only remote start the vehicle in neutral gear, on a flat surface and with a functional, fully engaged parking brake. Do not allow anyone to stand in front of or behind the vehicle.

This product should **not** be installed in any convertible vehicles, soft or hard top with a manual transmission. Installation in such vehicles may pose certain risk.

## What is included

---

- Remote Control 2 way LCD - (p/n 7752X)
- Remote Control 1 way companion - (p/n 7652X)
- The control module
- Control center with integrated status LED and Valet Override switch (p/n 6711T)
- Revenger™ Soft Chirp™ six-tone programmable siren
- A remote start defeat toggle switch

## Installation points to remember

---

This product is designed for fuel-injected, automatic transmission, or vehicles with manual transmissions.

**Important:** The default option “Manual Transmission Mode” is a safety precaution that forces the installer to enable the Manual Transmission Start (MTS) routine or program the unit to the “Automatic Transmission” option before the remote start can be activated for the first time.

The “Automatic Transmission” option should be programmed on to work with automatic transmissions. When the “Manual Transmission” option is selected a specific routine is required before exiting the vehicle to enable the MTS mode.

### ➤ Virtual Tach

Virtual Tach is a new feature for Directed this year. It is the default RPM-sensing method for the new Responder LC hybrid security/remote start systems. Virtual Tach gives the installer the performance of a hardwired tach wire, with the convenience of voltage sensing. It is far superior to any voltage-sense feature you’ve tried before.

Virtual Tach monitors the cranking voltage of the vehicle using a very fast microcontroller and an analog-to-digital converter. The microprocessor “saves” the base voltage as a reference. When Virtual Tach “sees” the slightest uptick in voltage, indicating that the alternator is charging the battery, the starter motor shuts off instantly.

## ➤ D2D

The system has the ability to interface with an XK module through the D2D port. The advantage to using a D2D interface is that there is less wiring involved in the installation. Check the XK module installation guide to determine which wires are not needed, and which options are available.

## ➤ The control center

The control center position should be discussed with the vehicle's owner prior to installation. The LED and Valet switch is housed on the control center, so you may want to check that the customer is satisfied with the location.



## ➤ Valet® program switch

The valet/program switch is built into the control center.

**Important:** When the vehicle is delivered, please show the user where this switch is located and how to disarm the system with it.

**Note:** An optional valet switch (p/n #8631) is available if the onboard valet switch is not used for the install.

When installing the external valet switch ensure that the location has sufficient clearance to the rear. The switch should be well hidden. It should be placed so passengers or stored items (such as in a glove box or center console) cannot accidentally activate it. The switch fits into a 9/32-inch hole.

## ➤ Status LED

The status LED is built into the control center. An optional LED (p/n 8634) is available if the onboard LED is not used for the install. The LED fits into a 9/32-inch hole.



## ➤ **Doubleguard shock sensor**

Since the shock sensor is built into the main unit, be sure to keep the shock sensor performance in mind when deciding on a location for the main unit.

**Note:** In many vehicles, fastening the main unit (the brain) to a steering column or screwing it to metal will result in poor sensitivity, especially at the rear of the vehicle.

## ➤ **Before beginning the installation**

- Please read this entire installation guide before beginning the installation. The installation of this remote start system requires interfacing with many of the vehicle's systems. Many new vehicles use low-voltage or multiplexed systems that can be damaged by low resistance testing devices, such as test lights and logic probes (computer safe test lights). Test all circuits with a high quality digital multi-meter before making connections.
- Do not disconnect the battery if the vehicle has an anti-theft-coded radio. If equipped with an air bag, avoid disconnecting the battery if possible. Many airbag systems display a diagnostic code through their warning lights after they lose power. Disconnecting the battery requires this code to be erased, which can require a trip to the dealer.
- If using an external LED or Valet Switch, check with the customer about where to locate the switch.
- To avoid accidental battery drainage; turn off the interior lights or remove the dome light fuse.
- Roll down a window to avoid being locked out of the car.

## ➤ **After the installation**

- Test all functions. The "Using Your System" section of the Owner's Guide is very helpful when testing.
- When testing, don't forget that this system is equipped with Nuisance Prevention® Circuitry (NPC). NPC can bypass trigger zones, making them appear to stop working. See the Nuisance Prevention® Circuitry section in the owners guide.
- Review and complete the Safety Check section of this guide prior to the vehicle reassembly.

## Component locations and finding wires

---

For detailed information on where to locate components, and how to find the wires you need, please refer to the Direct Tech web site at [www.directechs.com](http://www.directechs.com).

## Making your wiring connections

---

Before making your connections, plan how your wires are to be routed through the vehicle. For instance, the red 12V constant input and the remote start ignition wires are often routed together to the ignition switch harness. In order to keep the wiring neat and make it harder to find, you may wish to wrap these wires together in electrical tape or conceal them in tubing similar to what the manufacturer used.

There are two acceptable ways of making a wire connection - solder connections and crimp connectors. When properly performed, either type of connection is reliable and trouble-free. Regardless of whether you solder your connections or you use mechanical type crimp-on connections, ensure that all connections are mechanically sound and that they are insulated, especially when connecting data lines in the vehicle.

Cheap electrical tape, especially when poorly applied, is not a reliable insulator. It often falls off in hot weather. Use good quality electrical tape or heat shrink.

- Never twist-and-tape the wires together without soldering.
- Never use "fuse taps", as they can damage fuse box terminals.

If you use tapping connectors such as T-Taps (not to be confused with Scotch-Locks), avoid using them in higher-current applications (constant 12V, ground, etc.) These connectors are inferior in quality and should be avoided.

## ➤ Primary harness (H1), 12-pin connector

H1/1	RED/WHITE	(-) 200mA TRUNK RELEASE OUTPUT
H1/2	RED	(+)12v CONSTANT INPUT
H1/3	BROWN	(+) SIREN OUTPUT
H1/4	WHITE/BROWN	LIGHT FLASH ISOLATION WIRE - PIN 87a of onboard relay
H1/5	BLACK	(-) CHASSIS GROUND
H1/6	VIOLET	(+) DOOR TRIGGER INPUT
H1/7	BLUE	(-) TRUNK PIN/ INSTANT TRIGGER INPUT
H1/8	GREEN	(-) DOOR TRIGGER INPUT
H1/9	BLACK/WHITE	(-) 200mA DOME LIGHT OUTPUT
H1/10	WHITE/BLUE	(-) REMOTE START/ TURBO TIMER ACTIVATION INPUT
H1/11	WHITE	PARKING LIGHT OUTPUT
H1/12	ORANGE	(-) 500mA GROUND WHEN ARMED OUTPUT

## ➤ Auxiliary harness (H2), 8-pin connector

H2/1	LIGHT GREEN/ BLACK	(-) 200mA FACTORY ALARM DISARM OUTPUT
H2/2	LIGHT GREEN/ WHITE	(-) 200mA FACTORY ALARM ARM OUTPUT
H2/3	WHITE/VIOLET	(-) 200mA AUX 1 OUTPUT
H2/4	VIOLET/BLACK	(-) 200mA AUX 2 OUTPUT
H2/5	WHITE/BLACK	(-) 200mA AUX 3 OUTPUT
H2/6	LIGHT BLUE	(-) 200mA 2ND UNLOCK OUTPUT
H2/7	GRAY/BLACK	(-) DIESEL WAIT TO START INPUT
H2/8	BROWN/BLACK	(-) 200Ma HORN HONK OUTPUT

There are three harness connections relative to remote start function, including the heavy gauge and input and output harnesses.

## ➤ Heavy gauge remote start, (H3) 10-pin connector

H3/1	PINK	(+) IGNITION 1 INPUT/OUTPUT
H3/2	RED/WHITE	(+) FUSED (30A) IGNITION 2 / FLEX RELAY INPUT 87
H3/3	ORANGE	(+) ACCESSORY OUTPUT
H3/4	VIOLET	(+) STARTER OUTPUT (CAR SIDE OF THE STARTER KILL)
H3/5	GREEN	(+) STARTER INPUT (KEY SIDE OF THE STARTER KILL WIRE)
H3/6	RED	(+) FUSED (30A) IGNITION 1 INPUT
H3/7	PINK/WHITE	(+) IGNITION 2 / FLEX RELAY OUTPUT
H3/8	PINK/BLACK	(+) FLEX RELAY INPUT 87A key side (if required) of FLEX RELAY
H3/9	RED/BLACK	(+) FUSED (30A) ACCESSORY/STARTER INPUT
H3/10	NC (no connection)	NC

## ➤ Remote start input, 5-pin connector

1	BLACK/WHITE	(-) NEUTRAL SAFETY SWITCH INPUT
2	VIOLET/WHITE	TACHOMETER INPUT WIRE
3	BROWN	(+) BRAKE SHUTDOWN INPUT WIRE
4	GRAY	N/O or N/C (-) HOOD PIN SWITCH INPUT
5	BLUE/WHITE	(-) 200 mA 2ND STATUS/REAR DEFOGGER OUTPUT

## ➤ Remote start auxiliary output, 5-pin

1	PINK/WHITE	(-) 200mA FLEX RELAY CONTROL OUTPUT
2	ORANGE	(-) 200mA ACCESSORY OUTPUT
3	VIOLET	(-) 200mA STARTER OUTPUT
4	PINK	(-) 200mA IGNITION 1 OUTPUT
5	BLUE	(-) 200mA STATUS OUTPUT

**Note:** Wires 1 - 4 on the remote auxiliary outputs are wired to the (-) triggers for

the onboard remote start relays and are not diode isolated. If connecting these wires directly to the vehicle you must place a 1-amp diode in line to prevent feedback from the vehicle.

### ➤ Door lock harness, 3-pin connector

<b>1</b>	BLUE	(+) LOCK (-) UNLOCK OUTPUT
<b>2</b>	EMPTY	NOT USED
<b>3</b>	GREEN	(-) LOCK (+) UNLOCK OUTPUT

# Wire connection guides

## ➤ Primary harness (H1)

H1/1

RED/WHITE

(-) 200mA TRUNK RELEASE OUTPUT

When the system receives the code controlling trunk release output for longer than 1.5 seconds, the red/white wire supplies an output as long as the transmission continues. This is typically used to operate a trunk/hatch release or other relay-driven function.

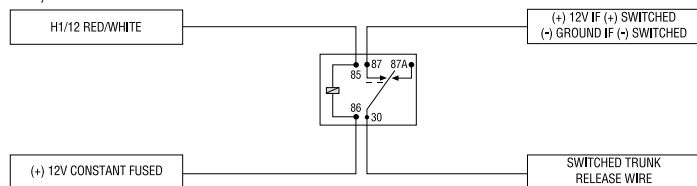

**Warning!** Never use this wire to drive anything but a relay or a low-current input! The transistorized output can only supply 200mA of current. Connecting directly to a solenoid, motor, or other high-current device will cause it to fail.

H1/2

RED

(+)12v CONSTANT INPUT

Before connecting this wire, remove the supplied fuse. Connect to the battery positive terminal or the constant 12V supply to the ignition switch.

**Note:** Always use a fuse within 12 inches of the point you obtain (+)12V. Do not use the 15A fuse in the harness for this purpose. This fuse protects the module.

H1/3

BROWN

(+) SIREN OUTPUT

Connect this to the red wire of the siren . Connect the black wire of the siren to (-) chassis ground, preferably at the same point you connected the control module's black ground wire.

This wire connects to pin 87a of the onboard light flash relay. It is used whenever light switch isolation on the vehicle is necessary. If the vehicle has a multiplex circuit that needs the light switch isolated, you can remove the onboard light flash fuse and replace it with the specified resistor (paying attention to the polarity selection).

### Multiplex Lightflash Interface

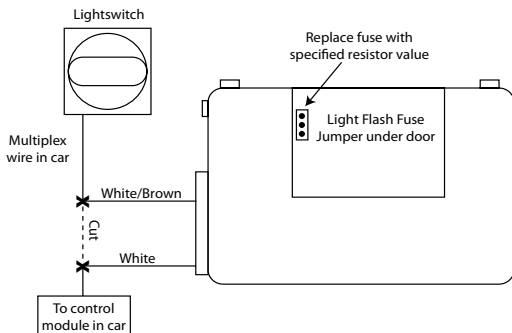

We recommend that you do not use a factory ground. Ground all your components to the same point in the vehicle, (preferably the kick panel). Scrape away any paint and use a factory bolt or make your own ground with a self-tapping screw and a star washer.

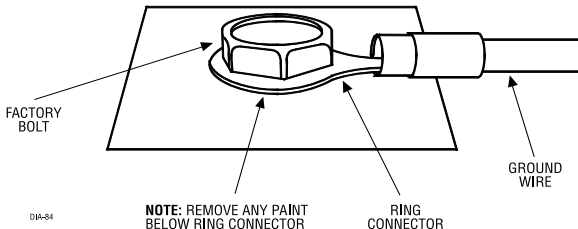

**H1/6****VIOLET****(+) DOOR TRIGGER INPUT**

This wire is used in vehicles that have a positive (+) switched dome light circuit. Connect the violet wire to a wire that shows (+) 12V when any door is opened, and ground when the door is closed.

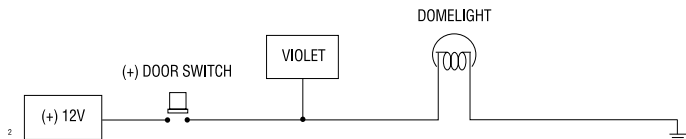
**H1/7****BLUE****TRUNK PIN / INSTANT TRIGGER INPUT**

This input responds to a negative input with an instant trigger.

**H1/8****GREEN****(-) DOOR TRIGGER INPUT**

Most vehicles use negative door trigger circuits. Connect the green wire to a wire which shows ground when any door is opened. In vehicles with factory delays on the dome light circuit, there is usually a wire that is unaffected by the delay circuitry.

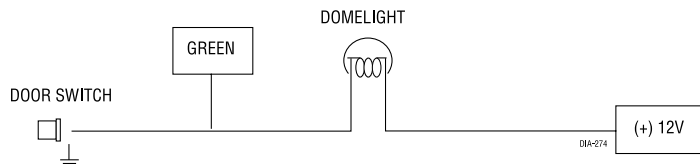
**H1/9****BLACK/WHITE****(-) 200mA DOME LIGHT OUTPUT**

Connect this wire to the optional dome light supervision relay as shown below: Important! This output is only intended to drive a relay. It cannot be connected directly to the dome light circuit, as the output cannot support the current draw of one or more light bulbs.



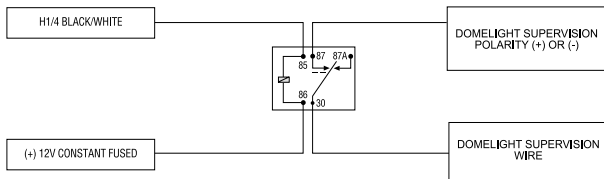

<b>H1/10</b>	<b>WHITE/BLUE</b>	<b>(-) REMOTE START/ TURBO TIMER ACTIVATION INPUT</b>
--------------	-------------------	---

This input comes from the factory set to 1 activation pulse. This means that it is necessary to have a single ground pulse on the white/blue wire for the remote start to activate or to deactivate.

The **H1/10** wire can also be used to activate the Turbo Timer mode when the car is running and this wire receives a ground.

**Note:** The number of activation inputs can be programmed to 1 or 2 pulses with an optional momentary switch. This setting affects both the input wire and the remote control when operating the remote starter.

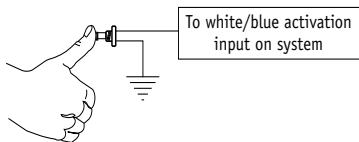

<b>H1/11</b>	<b>WHITE</b>	<b>PARKING LIGHT OUTPUT</b>
--------------	--------------	-----------------------------

This wire should be connected to the parking light wire in the vehicle. See Setting the light flash polarity section of this guide for polarity settings.

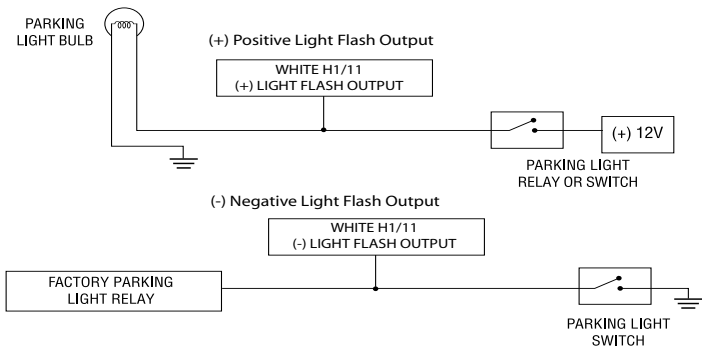

**Note:** For parking light circuits that draw 10-amps or more, the internal jumper must be switched to a (-) light flash output. (See Setting the light flash polarity section of this guide.) P/N 8617 or a standard automotive SPDT relay must be used on the H1/11 light flash output harness wire.

<b>H1/12</b>	<b>ORANGE</b>	<b>(-) 500mA GROUND WHEN ARMED OUTPUT</b>
--------------	---------------	---

This wire supplies a (-)500 mA ground as long as the system is armed. This output ceases as soon as the system is disarmed. The GWA can be hooked up to a window module, a voice module or any accessory that requires a ground when armed.

## ➤ Auxiliary harness (H2)

<b>H2/1</b>	<b>LIGHT GREEN/BLACK</b>	<b>(-) 200mA FACTORY ALARM DISARM OUTPUT</b>
-------------	--------------------------	--

This wire sends a negative pulse every time the remote start is activated, trunk release is activated (programmable on/off) or when the doors are unlocked with the remote. This can be used to pulse the disarm wire of the vehicle's factory anti-theft device. Use a relay to send a (-) or (+) pulse to the disarm wire as shown in the following diagrams.

## Relay for Negative (-) Disarm Wire

## Relay for Positive (+) Disarm Wire

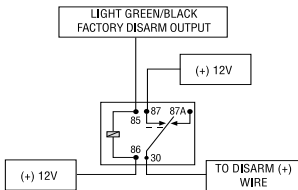
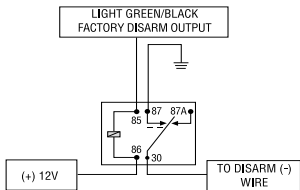

09-120

**H2/2**

**LIGHT GREEN/WHITE**

**(-) 200mA FACTORY ALARM ARM OUTPUT**

This wire sends a negative pulse every time the remote start shuts down or when the doors are locked with the remote. This can be used to pulse the arm wire of the vehicle's factory anti-theft device. Use a relay to send a (-) or (+) pulse to the arm wire.

**H2/3**

**WHITE/VIOLET**

**(-) 200mA AUX 1 OUTPUT**

This wire provides 200 mA programmable output whenever the transmitter buttons controlling Aux 1 channel is pressed. (See descriptions for Aux 3)



**Warning!** Never use this wire to drive anything but a relay or a low-current input! This transistorized output can only supply 200 mA. Connecting directly to a solenoid, motor, or other high-current device will cause the module to fail.

**H2/4**

**VIOLET/BLACK**

**(-) 200mA AUX 2 OUTPUT**

This wire provides 200 mA programmable output whenever the transmitter buttons controlling Aux 2 channel is pressed. (See descriptions for Aux 3.)



**Warning!** Never use this wire to drive anything but a relay or a low-current input! This transistorized output can only supply 200 mA. Connecting directly to a solenoid, motor, or other high-current device will cause the module to fail.

H2/5

WHITE/BLACK

(-) 200mA AUX 3 OUTPUT

This wire provides 200 mA programmable output whenever the transmitter button(s) controlling Aux 3 is pressed. This output can be programmed to provide the following types of outputs

- Validity: Output that sends a signal as long as the transmission is received.
- Latched: Output that sends a signal when the Aux channel button is pressed and continues until the same button is pressed.
- Latched, reset with ignition: Similar to the latched output, this type of output turns On the first time the Aux channel button is pressed, and turns Off the next time the same button is pressed. This type of output additionally stops and resets whenever the ignition is turned On and then Off.
- 30 seconds timed: The output sends a continuous signal for 30 seconds.

**Note:** Bitwriter® programs from 1 to 90 seconds.



**Warning!** Never use this wire to drive anything but a relay or a low-current input! This transistorized output can only supply 200 mA. Connecting directly to a solenoid, motor, or other high-current device will cause the module to fail.

H2/6

LIGHT BLUE

(-) 200mA 2ND UNLOCK OUTPUT

This wire produces a (-) 200mA output for progressive locks in which the driver door unlocks first and the remaining locks unlock with a second press of the unlock button on the remote.

**Note:** This feature needs to be programmed "On" to function correctly (see System Feature Menu #1, feature #8).

H2/7

GRAY/BLACK

(-) DIESEL WAIT TO START INPUT

Connect this wire to the wire in the vehicle that sends the signal to turn on the WAIT-TO-START bulb in the dashboard. In most diesels the wire is negative (ground turns on the bulb) and the GRAY/BLACK wire can be directly connected to the wire in the vehicle. If the vehicle uses a positive wire (12V to turn on the bulb) a relay must be used to change the polarity.

The system has a programmable onboard timer (See Feature menu #3, feature #9) so it is not mandatory to connect to the wait-to-start wire in the vehicle.

**Note:** A 1-amp diode must be installed in line on the factory wire between the wait-to-start indicator and the ECM. (See the following diagram for details).

(-) WAIT TO START WIRE

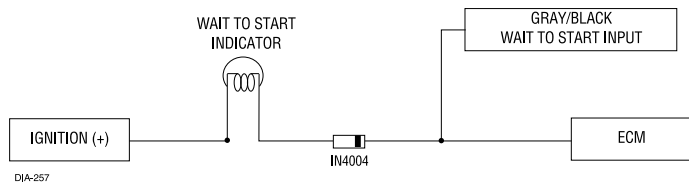

(+) WAIT-TO-START WIRE

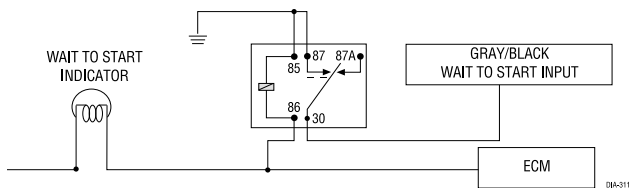

**H2/8****BROWN/BLACK****(-) HORN HONK OUTPUT**

This wire is low current output (200mA) and can be hooked to the horn honk wire in the vehicle. It can be programmed to sound only during full trigger or to be used like a siren output with arm/disarm honks. Refer to System Features Menu#1, Feature 10, for more information.

### ➤ **Heavy Gauge, 10-pin connector**

There are 9 heavy gauge wires coming from the large 10-pin connector. They are used to energize the ignition circuits in the vehicle. It is crucial to ensure that these connections are capable of handling the current demands. For this reason, Scotch-Locks, T-taps and other such connectors are strongly discouraged.

**H3/1****PINK****IGNITION 1 INPUT/OUTPUT**

Connect this wire to the ignition wire in the vehicle. This wire not only supplies voltage for the ignition line in the vehicle, it is also the ignition feed for the security system.

**H3/2****RED/WHITE****(+) (30A) FUSED IGNITION 2 / FLEX RELAY INPUT 87**

This wire is the polarity feed for the ignition 2/flex relay.

**H3/3****ORANGE****ACCESSORY OUTPUT**

Connect this wire to the accessory wire that powers the climate control system.

**H3/4****VIOLET****STARTER OUTPUT**

This wire hooks up to the starter side of the starter wire in the car. This wire is also pin 30 of the onboard starter kill relay.

**H3/5****GREEN****STARTER INPUT**

After cutting the starter wire connect the GREEN wire to the end going to the ignition switch. This wire is pin 87a of the onboard starter kill relay.

**H3/6**

RED

**(+) (30A) FUSED IGNITION 1 RELAY INPUT**

This wire is the polarity feed for the Ignition 1 relay.

**H3/7**

PINK/WHITE

**(+) IGNITION 2 FLEX RELAY OUTPUT**

This wire is factory programmed as Ignition 2 and can be programmed as a 2nd accessory or as a 2nd starter.

**H3/8**

PINK/BLACK

**87a OF IGNITION 2 FLEX RELAY**

This wire is used when an ignition switch isolation on the vehicle is necessary. This is common on Toyota and Nissan's which require the use of Tech Tip document #1077. (See Menu #3, Feature #8, for programming options)

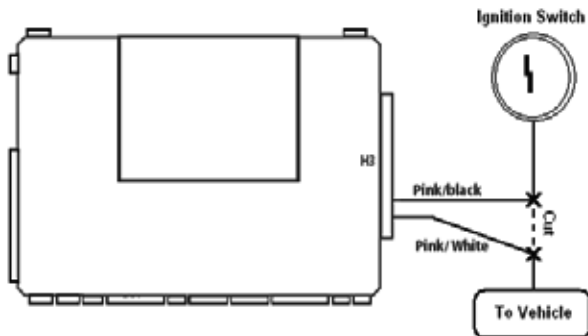
**H3/9**

RED/BLACK

**(+) (30A) FUSED ACCESSORY/STARTER RELAY INPUT**

This wire is the polarity feed to the accessory and starter relays.

## ➤ Remote start input - 5-pin connector

1

BLACK/WHITE

(-) NEUTRAL SAFETY SWITCH INPUT

Connect this wire to a ground source if installing this unit in an automatic transmission vehicle. If this unit is being installed in a manual transmission vehicle then connect it to the emergency brake wire. This input **MUST** rest at ground in order for the remote start system to operate.

Important! Always perform the steps outlined in Safety Check section to verify that the vehicle cannot be started in ANY drive gear and that the override switch is functioning properly.

2

VIOLET/WHITE

TACHOMETER INPUT WIRE

This input provides the module with information about the engine's revolutions per minute (RPMs). It can be connected to the uncommon colored wire of the fuel injector, the crankshaft position sensor, the camshaft position sensor or the negative side of the coil in vehicles with conventional coils. In multi-coil and high energy ignition systems locating a proper signal may be more difficult. (See Finding the Wires You Need section of this guide.) Once connected, you must teach the system the tach signal.

**Note:** This wire **MUST** be used when installing this unit on a manual transmission.

3

BROWN

(+) BRAKE SHUTDOWN WIRE

This wire **MUST** be connected to the vehicle's brake light wire. This is the wire that shows (+) 12V when the brake pedal is depressed. The remote start is disabled or shuts down any time the brake pedal is depressed. Note: This wire **MUST** be used when installing this unit on a manual transmission.

4

GRAY

N/O or N/C (-) HOOD PIN SWITCH INPUT

This wire **MUST** be connected to a hoodpin switch. This input disables or shuts down the remote start when the hood is opened. It also triggers the security system if the hood is opened while the system is armed. (See Feature Descriptions, Menu #1 feature #11 for details about programming.)



<b>5</b>	<b>BLUE/WHITE</b>	<b>(-) 200 mA 2ND STATUS/REAR DEFOGGER</b>
----------	-------------------	--

This wire supplies a 200mA output as soon as the module begins the remote start process. The Blue/White wire can also be used to activate the defogger trigger (latched/pulsed) 10-seconds after the remote start engages. (See the Feature Descriptions, Menu#3, feature #11 for details about programming this output).

### ➤ Remote start auxiliary output, 5-pin

These signals are provided to drive additional optional relays.

<b>1</b>	<b>PINK/WHITE</b>	<b>(-) 200mA FLEX RELAY CONTROL OUTPUT</b>
----------	-------------------	--

This wire is programmed as (-) 2nd ignition output from factory and can be programmed (to drive a relay) as a (-) starter or an accessory output.

<b>2</b>	<b>ORANGE</b>	<b>(-) 200mA ACCESSORY OUTPUT</b>
----------	---------------	-----------------------------------

This wire works like the main accessory wire and can be used (with a relay) to drive any additional accessory circuits in the vehicle.

<b>3</b>	<b>VIOLET</b>	<b>(-) 200mA STARTER OUTPUT</b>
----------	---------------	---------------------------------

This wire works like the starter wire and can be used (with a relay) to drive any additional starter circuits in the vehicle.

<b>4</b>	<b>PINK</b>	<b>(-) 200mA IGNITION 1 OUTPUT</b>
----------	-------------	------------------------------------

This wire works like the ignition 1 wire and can be used (with a relay) to drive any additional ignition circuits in the vehicle.

**Note:** Wires 1 - 4 on the remote start auxiliary outputs are wired to the (-) triggers for the onboard remote start relays and are not diode isolated. If connecting these wires directly to the vehicle you must place a 1-amp diode in line to prevent feedback from the vehicle.

This wire supplies an output as soon as the module begins the remote start process. It can be used to activate a bypass module or power the key sense wire in most vehicles to disarm the factory alarm without unlocking.

**Note:** Check vehicle information to verify if a bypass module is needed or if the key sense wire is needed.

## ➤ Door lock wire diagrams

**Important:** Depending on the vehicle, the door locks may be controlled by an optional data bus expansion module. If so, no door lock interface wiring is required.

There are eight different types of door lock systems (Type A - H). The more common type of door lock systems are Type A or Type B. Any other, Types C thru H, require external relays or a Directed Electronics 451M.

**Type A:** Three-wire (+) pulse controlling factory lock relays.

**Type B:** Three-wire (-) pulse controlling factory lock relays.

**Type C:** Direct-wired reversing-polarity switches. The switches are wired directly to the motors. This type of system has no factory relays.

**Type D:** Adding one or more aftermarket actuators. These include central locking systems without an actuator in the driver's door, but with factory actuators in all the other doors.

**Type E:** Electrically-activated vacuum systems.

**Type F:** One-wire system - cut to lock, ground to unlock. This is a very rare system found mainly in early 90's imports and some newer Hyundai models.

**Type G:** Positive (+) multiplex. One wire controls lock and unlock using resistor(s).

**Type H:** Negative (-) multiplex. Same as Type G system, but uses (-) pulse instead.

**Note:** You can use a 456L door lock learn module for Type G and H, instead of relays and resistors. For additional information and wiring diagrams see Document 1041 on [www.directechs.com](http://www.directechs.com) under Resource tab.

# Neutral safety switch interface

---

Some vehicles do not have an electrical neutral safety switch. Instead, the vehicle has a mechanical neutral safety switch that physically interrupts the starter wire and is used when the vehicle is in any drive gear. If the remote start is interfaced before this switch, it will provide protection from starting in gear. However, some vehicles combine the column shift mechanism and the mechanical neutral safety switch into one mechanical part.

**Important:** You must complete the remote start system installation before doing the following test. Ensure that the remote start system is functioning normally. This includes connecting to the brake as a shut-down.

## ➤ Testing the neutral safety switch

1. Make sure there is adequate clearance to the front and rear of the vehicle because it may move slightly.
2. Make sure the hood is closed and there are no remote start shut-downs active.
3. Set the emergency brake.
4. Turn the key to the "run" position, this releases the shifter.
5. Place the car in drive (D).
6. Place your foot directly over the brake pedal, but do not depress it. Be ready to step on the brake if the starter engages.
7. Activate the remote start system.
8. If the starter engages, immediately depress the brake to shut the remote start system down. If the starter does not engage, no additional safety system is required.

If the starter engages and the vehicle is a General Motors product or Dodge Dakota pickup, refer to [www.directechs.com](http://www.directechs.com) for Document 1008 under the Resource tab. for an alternative shut-down method which prevents the starter from engaging. If the vehicle is not a General Motors product or a Dodge Dakota pickup, please call Directed Electronics Technical Support for an alternative shut-down method. **Do not return the vehicle to the customer until this feature is properly installed!**

## Plug-in LED and valet/program switch

---

The LED and valet switch are incorporated into the control center, the LED line plugs into the white 2-pin port and the Valet switch line plugs into the blue 2-pin port.

**Note:** Onboard LED and valet switch can be substituted with an optional outboard LED (P/N 8634 for Blue LED and 8633 for red LED) and an outboard valet switch (P/N 8631).

## Bitwriter interface - 3-pin black plug

---

The black 3-pin port is provided for programming the unit using the Bitwriter (p/n 998T). When using the Bitwriter, it is possible to configure any and all of the programmable functions as well as lock the Remote Control and System Features Learn Routines so that unauthorized users cannot change the configuration or program remote controls to the unit.



When the learn routines have previously been programmed using the Bitwriter, they may have been locked. Before proceeding with reprogramming the learn routines, they must be unlocked with the Bitwriter - this cannot be done manually with the Valet switch.

**Note:** Bitwriters require software v2.6. Bitwriters with a date code of 6a or older require an IC upgrade (p/n 998M). Some Bitwriters with a date code of 6B do not require the IC upgrade, refer to tech tip # 1112 for more information. Bitwriter 2 compatible.

## Optional sensor port - 4-pin connector

---

There is a shock sensor built onboard the main unit. This connector is an optional sensor port to add sensors to the security system. Optional sensors that may be used are: 508D Doubleguard Proximity Field Disturbance, 509U Ultrasonic Sensor, 506T Glass Break Sensor, and 507M Digital Tilt Sensor.

This input can also be used for a second 504D Doubleguard Shock Sensor, or for additional pin and magnetic switches.

Alarm trigger inputs shorter than 0.8 seconds trigger the WarnAway response, while inputs longer than 0.8 seconds triggers the Full Alarm sequence.

**Note:** You need to add a 4-pin plug to interface with any hardwired switches

## Tachometer settings

---

### ➤ Virtual tach

#### To program Virtual Tach:

1. After the install is complete, remote start the car.
2. If the car does not start on the first attempt, let the remote start attempt again.
3. Once the car starts, let it run until the parking lights come on.
4. When the parking lights come on, shut off the remote start with the remote - that's it! Virtual Tach is programmed.

To reset Virtual Tach, go into the remote programming grid and choose option #4. Virtual Tach **cannot** be reset with the Bitwriter.

**Note:** Virtual Tach cannot be used in MTS Manual Transmission Mode.

Virtual Tach handles disengaging the starter motor during remote starting – it does not address over-rev. If the customer wants to have the over-rev protection capability, the tach wire must be connected. This may involve more installation shop charges than initially quoted.

**Important:** If the Virtual Tach mode over cranks or doesn't crank the vehicle long enough to start and run the car, use the Bitwriter to add or subtract the starter output time. You can adjust the output time in increments of 50mSec of the learned time using the Bitwriter.

## ➤ Tach learning

To learn the tach signal:



1. Start the vehicle with the key.



2. Within 5 seconds, press and hold the Valet/Program switch.



3. After 3 seconds the LED lights constant when the tach signal is learned.

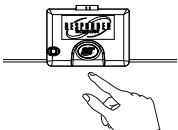

4. Release the Valet/Program switch.

## ➤ Tach threshold On/Off

In most cases, this jumper can be left in the Off position. Some new vehicles use less than 12 volts in their ignition systems. The unit may have trouble learning the tach signal in these vehicles. Changing the jumper to the On setting changes the trigger threshold of the digital tach circuit so that it works with these type vehicles.

TACH THRESHOLD OFF (DEFAULT)



TACH THRESHOLD ON

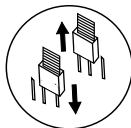

TO CHANGE  
JUMPER  
SETTINGS

## D2D Jumper settings

---

The security system has the ability to work with a compatible module through the D2D lines. There are two settings: one for using an internal docking module, (p/n XK 400N) or an external docking XK module.

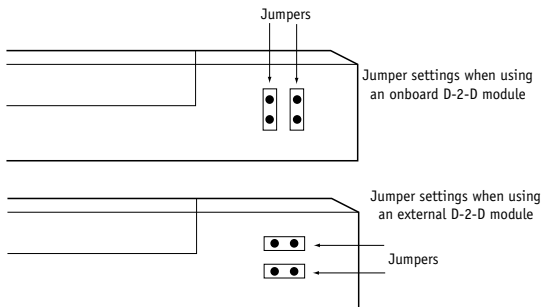

## Setting the light flash polarity

---

### Light flash (+) / (-) polarity



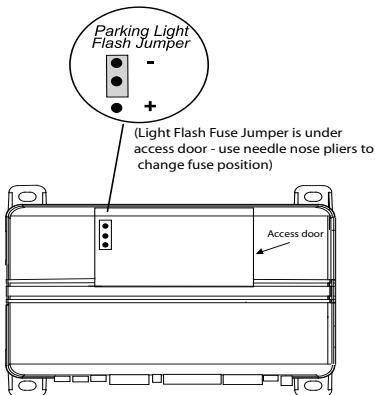

The internal fuse is used to determine the light flash output. In the (+) position, the onboard relay outputs (+)12V on the WHITE wire, H1/11. In the (-) position, the on-board relay will supply a (-) output. When wiring into a multiplex circuit, you can replace the fuse with a resistor (paying attention to the polarity setting). (Refer to diagram on p. 16, H1/4 White/ Brown wire description).

**Note:** For parking light circuits that draw 10 amps or more, the internal jumper must be switched to a (-) light flash output. P/N 8617 or a standard automotive SPDT relay must be used on the H1/11 light flash output harness wire.





## ➤ Impact Sensor Adjustment

Make sure the keypad is unlocked and the vehicle is disarmed with no open zones.

- Press and hold the **f** button on the remote for approximately 8 seconds (at 3 seconds ignore the car select indicator) and continue holding.
- The status screen clears and the LCD text displays "main menu". Release the **f** button and the LCD text changes to the remote setup options table.
- Pressing the  button steps up one Main Menu option per press.
- Pressing the  button steps down one Main Menu option per press.
- When the desired Main Menu option (Sensor Adjust) is displayed on the LCD text press and hold the **f** button for 1 second, the remote beeps three times and the siren will emit one long chirp confirming entry into the sensor adjust mode.
- The LCD text displays the current level setting of the impact sensor.
- Pressing the  button increases the sensitivity up one level and pressing the  button decreases the sensitivity on level.
- When the desired level is reached, press **f** on the remote to lock in the setting.



At this point you can either re-adjust the sensor or press  or  to save and exit the programming. The siren will emit one long chirp when exiting the adjustment mode.

The Impact Sensor Adjustment Mode exits if there is no activity from the remote after 30 seconds.

Adjusting the impact sensor with the 1 way companion remote.

## Disarm system

Press/hold the **f** button of the remote control for 8 seconds or until the Amber LED turns on and you hear one long beep.

Press/hold the  button 1.5 seconds or until the amber led comes on solid.

The control module emits one long chirp, confirming that it has entered adjustment mode.

Press the , , or  buttons to adjust the sensor level.

Arm button: Pressing the  button increases the sensitivity one level. The siren chirps twice confirming the sensitivity adjustment.

Disarm button: Pressing the  button decreases the sensitivity one level. The siren chirps once confirming the sensitivity adjustment.

Remote Start button: Pressing the  button resets to default level 7. The siren chirps three times.

To exit the shock sensor adjustment mode from the remote control:

Press and release the **f** button any time during programming to go back to the main menu. Press and hold for 1.5 seconds in the main menu to exit programming.

To exit the shock sensor adjustment mode from the control module:

Open an entry point or turn on the ignition, the control module emits one long chirp when exiting adjustment mode.

# Remote control Learn Routine™



---

The system comes with a 1-way and a 2-way remote control that are already programmed to the system. The system can store up to 4 different remote control codes in memory.

The remote uses a Supercode Protocol and requires setup before programming the system.

## ➤ Remote Control Programming

### 2 way programming

1. Make sure the keypad is unlocked.
2. Press and hold the **f** button on the remote for approximately 8 seconds , at 3 seconds ignore the car select indicator and continue to hold. The LC text displays Main Menu until the **f** button is released.
3. Release the **f** button. The LC text displays the remote setup options table.
4. Pressing the  button steps up one Main Menu option per press and pressing the  button steps down one Main Menu option per press.
5. When the Pair Remote menu option is displayed, press and hold the button for 1 second. The remote emits 3 short beeps and the LC text displays Pair.
6. Now enter the remote control learn routine using the control center (as described on the following page) and choose the Auto learn standard configuration function listed on the program grid.

### 1 way programming:

Hold the **f** button on the remote until you hear it emit a long beep.

1. The transmit LED comes on solid (approximately 8 seconds).
2. Press and hold the  button and the amber Transmit LED lights up.
3. Next enter the remote control learn routine and choose the function for "auto learn configuration" listed on the program grid.

**Note:** You do not need to go through the setup for the other features in the menu.

After entering the setup mode on the remotes, use the following learn routine to add remote controls to the system.

If the siren generates one long chirp when attempting to program the unit, the learn routine is locked and must be unlocked using the Bitwriter® before proceeding.

The Valet/Program switch, plugged into the blue port, is used for programming. There is a basic sequence to remember whenever programming this unit: Door, Key, Choose, Transmit and Release.



1. Open a door. (The GREEN wire, H1/8, or the VIOLET, H1/6 must be connected.)



2. Insert the key. Turn the ignition to the ON position. The heavy gauge pink wire must be connected.



3. Choose. Within 10 seconds, press and release the Program switch corresponding to the number of the desired function step listed in the following table.

Once you have selected the function step, press the switch once more and hold it. The LED flashes and the siren chirps to confirm the selected functional step. Do not release the Program switch.

Step	Function
1	Auto Learn Standard Configuration* (default) The auto learn configuration automatically sets up the remote's button configuration. <b>Note:</b> Due to the Supercode protocol, you cannot change the configuration.

Step	Function
2	Delete remotes: This feature erases all remotes from the memory of the security system. This is useful in cases when a customer's remote is lost or stolen. <b>Note:</b> This does not reset the programmed features of the security system or reset the Virtual Tach setting.
3	Reset Features: This resets features all of the security system to the factory default settings. <b>Note:</b> This feature does not delete the remotes from the security system or reset the Virtual Tach setting.
4	Virtual Tach Reset: Deletes all previously learned values for Virtual Tach, and on the next remote start sequence the unit begins virtual tach initialization. <b>Note:</b> The "Zap" feature on the Bitwriter does not reset the Virtual tach setting.



4. Transmit. While holding the Valet/Program switch, press the  button on the remote control. The unit chirps to confirm that the code has been successfully programmed. It is not possible to teach a remote control button to the system more than once.

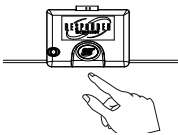

5. Release. Once the code is learned, the Valet/Program switch can be released. You can advance from one function step to another by releasing the Valet/Program switch and tapping it to advance function steps and then holding it.

#### Learn Routine is exited if:

- The door is closed
- The ignition is turned off
- The program switch is pressed too many times
- More than 30 seconds elapses between steps

# Remote control configuration

---

## ➤ Responder LC 2-way

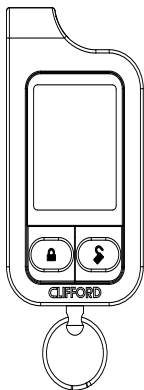





**Note:** If Keypad Lock is On, press **f** and then press  to exit.

**Note:** The one-way remote only has a transmit LED and does not report any confirmations or vehicle requests..

The remote control buttons that operate the features of the security and remote start system are described below. The buttons operate in this configuration when the remote control is programmed using the Step 1 Auto-learn routine.

For more information about the remote control functions, see the Owners Guide.

Level Button	Direct Access	<b>f</b> x 1	<b>f</b> x 2	<b>f</b> x 3	<b>f</b> x 4
	ARM/LOCK (Panic)	SILENT ARM	SENSOR BYPASS	SILENT ALARM SENSORS	SILENT ALARM ALL ZONES
	DISARM/UN-LOCK (Panic)	SILENT DISARM	VALET ON/OFF	CAR FINDER	
	STARTER ON/OFF	RESET RUNTIME	TIMER MODE ON/OFF	SMART START ON/OFF	DEFOGGER ON
	TRUNK RELEASE (Red/White)	AUX 1	AUX 2	AUX 3	
	Advance Level Change Car (3s) Enter programming (8s)	CABIN TEMPERATURE REQUEST	RUNTIME CHECK	EVENT HISTORY REPORT	

**Important:** To access "Cabin temperature request, Runtime check and event report history, press the **f** button the specified amount of times, and then hold.

## System features learn routine

The System Features Learn Routine dictates how the unit operates. It is possible to access and change any of the feature settings using the Valet/program switch. However, this process can be simplified by using the Bitwriter®. Any of the settings can be changed and then assigned to one of four remote controls. This feature is called Owner Recognition. Each time that particular remote control is used to disarm the system, the assigned feature settings are recalled. Owner Recognition is only possible when programming the unit via the Bitwriter®.



If programming with the Bitwriter®, the learn routine can be locked or unlocked. If the learn routine has previously been locked, it must be unlocked with Bitwriter® - this cannot be done manually with the Valet switch.



1. Open a door. (The GREEN wire, H1/8, or the VIOLET, H1/6 must be connected.)



2. Turn the ignition on, then off. (The heavy gauge PINK wire must be connected.)



3. Select a Menu. Press and HOLD the Valet/Program switch. (The Valet/Program switch must be plugged into the blue port.) After three seconds the siren chirps one-time, indicating entry to the Basic Features Menu. If this is the menu you want, release the button and go on to

If the button is not released, the program jumps to the next menu and the siren chirps twice. There are three possible menus. Select the menu you want, then release the Valet/Program switch.

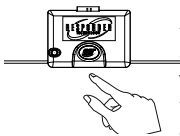

4. Select a Feature. Press and release the Valet/Program switch the number of times corresponding to the feature you wish to change. For example, to access the third feature, press and release 3 times. Then press the button once more and HOLD it. The siren chirps the number of

times equal to the feature you have accessed.





5. Program the Feature. While holding the Valet/Program switch, you can toggle the feature on and off using the remote control. Pressing the button that arms the system selects the options in increasing order. Pressing the button that disarms the system selects the options in descending

order. Pressing the button that activates the remote start resets the feature to the factory default.



6. Release. Valet/program switch.

**Note:** Some features have more than two possible settings. Pressing  or  toggles through the two-chirp and higher settings.

### **Once a feature is programmed:**

- Other features can be programmed within the same menu
- Another menu can be selected
- The learn routine can be exited if programming is complete

### **To access another feature in the same menu:**

1. Press and release the Valet/Program switch the number of times necessary to advance from the feature you just programmed to the next one you want to program.
2. Then press the Valet/Program switch once more and hold it.

For example, if you just programmed the third feature in the menu and you want to program the seventh feature in the menu, press and release the Valet/Program switch four times and then press it once more and hold it. The siren chirps seven times to confirm access to the seventh feature.

### **To select another menu:**

1. Press and hold the Valet/Program switch.
2. After three seconds, the unit advances to the next menu and the siren chirps, indicating which menu has been accessed.

If you just programmed features in the first menu and you want to program a feature in the third menu, press and hold the Valet/Program switch. After three seconds the siren chirps twice indicating access to the second menu. Continue to hold the button and three seconds later the siren chirps three times indicating access to the third menu.

Features in the third menu are then programmable following steps 4 through 6 of the System Features Learn Routine procedure.

### **The learn routine exits if any of the following occurs:**

- The open door is closed
- The ignition is turned On
- There is no activity for 30 seconds
- The Valet/Program switch is pressed too many times



# Feature menus

The default settings are indicated in bold type.

## ➤ Menu 1 - Security

Menu Item	Feature	Opt. 1	Opt. 2	Opt. 3	Opt.4	Opt. 5+
1	System Arming Mode	<b>Active</b>	Passive Arm w/o lock	Passive Arm w/ lock	Auto re-arm w/o lock	Auto re-arm w/ lock
2	Panic Mode	<b>On</b>	Ign Off only	Off		
3	Confirmation Chirps	<b>On w/Warn chirps On</b>	On w/Warn chirps Off	Off w/Warn chirps On	Off w/warn chirps Off	
4	Siren duration	<b>30 sec.</b>	60 sec.			
5	Ign-controlled locks	<b>No Ign-locking</b>	Lock & Unlock	Lock Only	Unlock Only	
6	DoorLock Pulses	<b>Single</b>	Double Un-lock Only	Double Lock Only	Double Lock & Unlock	
7	Door lock output duration	<b>0.8 sec.</b>	3.5 sec.	0.4 sec.		
8	2nd Unlock	<b>No 2nd Unlock</b>	2nd unlock on Ign-control after first unlock	2nd unlock on Ign-control with first unlock		
9	Comfort Closure	<b>No Comfort Closure</b>	Comfort Closure 1	Comfort Closure 2		
10	Horn function	<b>Full Alarm Only</b>	Siren Function 20 mS	Siren Function 30 mS	Siren Function 40 mS	Siren function 50 mS
11	Hood Trigger Type	<b>Normally Open</b>	Normally closed			
12	Sensor trigger	<b>Single</b>	Double			

## ➤ Menu 2 - Convenience

Menu Item	Feature	Opt. 1	Opt. 2	Opt. 3	Opt.4	Opt. 5+
1	Onetime Bypass	<b>One time bypass OFF</b>	One time bypass ON			
2	Nuisance Prevention	<b>ON</b>	Off			
3	Valet Switch Pulse Count	1	2	3	4	5
4	Door Trigger Error Chirp	<b>On</b>	Off			
5	Ign-controlled Dome light	<b>On</b>	Off			
6	OEM Alarm Disarm w/trunk release	<b>On</b>	Off			
7	OEM Alarm Disarm Output	<b>With Unlock</b>	Before Unlock	Remote Start Only		
8	OEM Alarm Disarm Pulses	1	2			
9	Aux 1 Output type	<b>Validity</b>	Latch	Latch/reset/ign	Timed 30 sec.	Off
10	Aux 1 Linking	<b>No Linking</b>	link to Arm	Link to Disarm	Link to Arm/disarm	Link to Remote Start only
11	Aux 2 Output type	<b>Validity</b>	Latch	Latch reset/ign	Timed 30 sec.	Off
12	Aux 2 Linking	<b>No Linking</b>	link to Arm	Link to Disarm	Link to Arm/Disarm	Link to Remote Start only
13	Aux 3 Output type	<b>Validity</b>	Latch	Latch reset/ign	Timed 30 sec.	Off
14	Aux 3 Linking	<b>No Linking</b>	Link to Arm	Link to Disarm	Link to Arm/Disarm	Smart Key Control (Link to Remote Start Off)

## ➤ Menu 3 - Remote start

Menu Item	Feature	Opt. 1	Opt. 2	Opt. 3	Opt.4	Opt. 5+
1	Transmission Mode	<b>Manual</b>	Automatic			
2	Engine Checking Mode	<b>Virtual Tach</b>	Voltage	Off	Tachometer	
3	Cranking Time	<b>0.6 sec.</b>	0.8 sec.	1.0 sec.	1.2 sec.	1.4 (5)/1.6(6)/1.8 (7) 2.0(8)4.0(9)
4	Remote Start Runtime	<b>12 min.</b>	24 min.	60 min.		
5	Activation Pulse Count	<b>1</b>	2			
6	Turbo Mode	<b>No Turbo Mode</b>	On-1 min.	On-3 min.	On-5 min.	
7	Timer Mode Runtime	<b>12 min.</b>	3 min.	6 min.	9 min.	
8	Flex Relay Function	<b>Ignition 2</b>	Accessory 2	Starter 2		
9	Diesel Start Delay	<b>Wait-to Start input</b>	Timed 15 sec.	Timed 30 sec.	Timed 45 sec.	
10	Accessory during Diesel Start Delay	<b>On</b>	Off			
11	Status 2 Output	<b>Status</b>	Latch Rear Defogger	Pulse Rear Defogger		
12	Parking Light Output	<b>Constant</b>	Pulsed	Off		
13	Anti-grind Output	<b>On</b>	Off			
14	Tach Mode Starter Release	<b>Normal</b>	Increase	Decrease		
15	Vehicle temp auto report	<b>Off</b>	On			

# Feature descriptions

---

The features of the system are described below. Features that have additional settings that can be selected only when programming with the Bitwriter® are indicated by the following icon: 

**Note:** The numbers in parentheses indicate the number of times the LED on the antenna flash. Default settings are in **bold**.

## ➤ Menu 1 - Security

**1-1 Active/Passive Arming: Active arming (1):** When active arming is selected, the system only arms when the transmitter is used.

Passive arming (2): When set to passive arming the system automatically arms 30 seconds after the last door is closed. To alert the user of passive arming, the siren chirps 20 seconds after the door is closed. This provides the user with an audible warning prior to the alarm actually arming. At the 30 second mark the system arms, but without the siren chirp.

Passive arm & lock (3): When set to passive arming and locking, the system arms the same as described above but also locks the doors at the 30 second mark.

Auto re-arm w/o lock (4): When the alarm is disarmed from the remote a 30 second timer starts and rearms the alarm.

Auto re-arm w/lock (5): Works the same as above with the addition of locking the doors when re-arming.

**Note:** The re-arm feature exits when any hardwired input on the alarm is activated and does not re-engage until the alarm receives a disarm command from the remote.

**1-2 Panic On: (1 LED flash)** This feature controls whether or not the panic mode is available with the ignition on. In some states there are laws prohibiting a siren continually sounding in a moving vehicle. This feature makes the system compliant with these regulations. The LED flashes twice (2) to indicate Panic with ignition Off. When the Panic feature is Off, the LED flashes (3)

**1-3 Arm/disarm and Warn Away CHIRPS ON: (1)** This feature controls the

chirps that confirm the arming and disarming of the system, Arm/Disarm chirps ON, w/Warn Away chirps OFF (2), Arm/disarm chirps OFF, w/ Warn Away chirps ON (3), Arm/disarm chirps OFF, w/Warn Away chirps OFF (4).

**1-4, 30 Second Siren Duration:**  It is possible to program the unit to sound for **30 (1)** or **60 (2)** seconds during the triggered sequence. Some states have laws regulating how long a security system can sound.

When using the Bitwriter®, the siren can be programmed to sound for any length of time from 1 second to 180 seconds.

**1-5 Ignition Locks Off:** (1) When turned Off the system does not lock/unlock the doors. (2) Lock and Unlock: The doors lock three seconds after the vehicles doors are closed when the ignition is turned On, and unlock when the ignition is turned Off. (3) Lock: Locks the doors three seconds after the ignition is turned On and the vehicles doors are closed. (4) Unlock: Unlocks the doors when the ignition is turned off.

**1-6 Single Pulse Lock/Unlock(1):** The system sends out a single pulse when locking and unlocking. (2) Double-pulse unlock sends out 2 pulses when unlocking. (3) Double-pulse lock sends out 2 pulses when locking. (4) Double-pulse lock/unlock sends out 2 pulses when locking and unlocking.

**1-7 0.8 sec. Door Lock Pulse Duration (1):** The default setting is 0.8 second door lock pulses. Some European vehicles, such as Mercedes-Benz and Audi, require longer lock and unlock pulses to operate the vacuum pump. Programming the system to provide 3.5 second (2) pulses, accommodates the door lock interface in these vehicles. (See door lock connections section for wiring information regarding Type E door locks interfacing. The 0.4 second (3) pulse is required on some vehicles where the lock wires can also control the windows and the 0.8 second pulse causes the windows to open/close when locking or unlocking.

**1-8 No 2nd Unlock Output (1):** The second unlock output is defeated at all times. (2) 2nd unlock On with ignition control, after first unlock turns on the 2nd unlock output and unlocks the passengers doors after the driver's door is unlocked with ignition controlled locks. (3) 2nd unlock on with ignition control with first unlock turns on the 2nd unlock output and unlocks the passengers doors at the same time the driver door is unlocked with ignition controlled locks.

**1-9 Comfort Closure Off(1):** The system can be programmed to close the windows when the system is locked. If programmed ON, the lock output provides a 20 second pulse when the system is locked. The output is cancelled if the unlock button is pressed. In the Off setting, the alarm does not perform this function.

(2) Comfort closure 1 - Activates the 20 second timer after the door lock pulse.

(3) Comfort Closure 2 - Activates the 20 second timer with the door lock pulse.

### To test if the car has the comfort closure:

1. Insert the key into the drivers door key cylinder.
2. Turn the key to the lock position and hold for about 10 seconds. If Comfort closure is available, the windows (and in some cars the sunroof) closes.

**Note:** Some cars require that you turn the key once, release it, and then turn and hold into the lock position.

**Important:** Comfort closure can only be used on cars that have the capability of closing the windows (and on some cars the sunroof as well) with the key cylinder in the door.

**1-10 HORN FUNCTION FULL ALARM ONLY (1):** SIREN FUNCTION - honk length 20mS (2) 30mS (3) 40mS (4) 50mS (5). Program for output when the alarm is fully triggered or as the siren (arming/disarming and Warn Away and full trigger with timing options).

**1-11 Hood Trigger (Normally Open) (1):** Hood trigger (normally closed (2). To program the unit for either a normally open (rests open, or at 12v when the hood is closed) or a normally closed (rests at ground when the hood is closed) pin switch.

**1-12 Sensor trigger (single) (1)** Sensor trigger double (2). When programmed on; any 2 sensors (zones 2, 4, 7) need to be triggered within 5 seconds of each other to trigger the alarm. When programmed off; each sensor triggers the alarm independently.

## ➤ Menu 2 - Convenience

**2-1 One time bypass Off (1):** One time bypass ON. When programmed On (2) the unit does not passively arm/lock for one cycle when turning the ignition On and Off within 3 seconds. When going through this procedure the siren chirps once indicating that One Time Bypass has been activated.

**2-2 Nuisance Prevention® Circuitry (NPC) On (1):** Nuisance Prevention Circuitry OFF (2). NPC stops repeated triggering of the same zone. If one zone is triggered three times in one hour, that zone is bypassed for one hour, starting from the time of the third trigger. During that hour, if the system sees a trigger on that zone again, the system resets the one hour timer.

If one hour passes and the zone has not triggered again, the zone is activated and can trigger the system again. NPC only monitors sensor inputs, and does not bypass the door trigger or the ignition trigger at any time.

If NPC is turned off, the system responds to repeated triggers on the sensor inputs and will do so indefinitely. Some states have laws regulating how many times a security system can trigger before it is considered a nuisance and the vehicle is towed away.

**2-3 Disarm from Valet, 1 pulse (1).** Disarm from valet, 2-5 pulses (2). The system can be programmed to count the number of presses of the valet switch before disarming the security system. The factory default setting is one pulse. The unit can also be set for two to five pulses.

**2-4 Door trigger error chirp On (1):** Door trigger error chirp Off (2). This feature controls the error chirp that is generated if the system is locked with the door trigger active. This is useful in vehicles with a long dome light delay after the door is closed. If the system is locked before the dome light turns Off, the system generates the door trigger error chirp. If this error chirp notification is not desired, use this feature to disable the door open error chirp notification. If the error chirp notification is turned Off, no bypass chirp is generated, even if a door is accidentally left open.

**2-5 Ignition Controlled Dome Light Supervision On (1):** If turned on, the system turns on the dome light for 60 seconds when the ignition is turned off. The op-

tional dome light supervision feature must be installed as described in the Wire Connection Guide. Ignition controlled dome light Off (2).

**2-6 FAD w/trunk release On (1):** FAD w/trunk release OFF (2). In the default setting the factory alarm disarm output disarms the factory alarm system any time the button controlling the trunk release output is pressed.

**2-7 Factory Alarm Disarm/With Unlock (1), Before Unlock (2), Remote Start Only (3):** In the default setting the factory alarm disarm output disarms the factory alarm system any time the button controlling Unlock or Remote Start is pressed. The "Before Unlock"(2) output disarms the factory alarm before the unlock output activates and when remote start is activated. The "Remote Start Only" (3) disarms the factory alarm only when the remote start is activated.

**2-8 FAD 1 pulse (1):** FAD 2 pulses (2). This setting determines how many pulses the security system outputs on the Factory alarm disarm wire.

**2-9 Aux 1 Validity (1)** Latched (2), Latch reset w/ignition (3), 30-sec. Timed (4)

- Validity: Output that sends a signal as long as the transmission is received.
- Latched: Output that sends a signal when the Aux 1 button(s) is pressed and continues until the same button(s) is pressed again.
- Latched, reset with ignition: Similar to the latched output this output type turns ON the first time the Aux 1 button(s) is pressed and turns OFF the next the same button is pressed. This output type additionally stops and resets whenever the ignition is turned ON, and then OFF.
- 30-second timed: Output that sends a continuous signal for 30 seconds.
- Off: Output is disabled.

**Note:** All auxiliary channel timed outputs can be programmed using the Bit-writer® (1-90 seconds)

**2-10 Aux 1 Linking, None (1)** Lock (2) Unlock (3) Lock/Unlock (4) Remote Start (5). When programming to Validity or timed output this can be programmed to activate when locking or unlocking (or remote start) with the transmitter.

**2-11 Aux 2 Validity (1)** Latched (2), Latch reset w/ignition (3), 30-sec. Timed,



(4) Output, (5) Off: Aux 2 can be programmed for these output configurations. The unit is set to the default validity output. To change the configuration use the two-chirp setting to toggle through the different configurations. Refer to feature 2-9 for additional details

**2-12 Aux 2 Linking None (1)** Arm (2) Disarm (3) Arm/Disarm (4) Remote Start (5). Refer to feature 2-10 for additional details.

**2-13 Aux 3 Validity (1)** Latched (2), Latch reset w/ignition (3), 30 -sec. Timed, (4), Off (5): Channel 3 can be programmed for these output configurations. The unit is set to the default validity output. To change the configuration use the two-chirp setting to toggle through the different configurations. Refer to feature 2-9 for additional details.

**2-14 Aux 3 Linking None (1)** Arm (2) Disarm (3) Arm/Disarm (4) Smart key control (link to remote start Off) (5). When Aux 3 is programmed to Smart Key control, this wire outputs a 800ms pulse when the Remote Start is shut Off. The alarm also monitors the door trigger input. When the door is opened during the remote start runtime, the remote start shuts down and this wire outputs the 800ms pulse.

**Note:** This wire should be connected to the wire at the push button that start/stops the car. It pulses the wire at the button to shut off the car when the remote start is deactivated.

## ➤ **Menu 3 - Remote start**

**3-1 Manual Transmission Mode (1):** Automatic transmission mode (2). In the default setting the remote start unit is programmed to look for a shutdown procedure to activate the remote start.

**3-2 Engine Checking Virtual Tach: (1)** When set to "virtual tach" the remote start monitors the cranking voltage of the vehicle and set that voltage as a reference point. Fifteen seconds after the crank output sequence the remote start checks the voltage again to determine if the vehicle is running.

When set to voltage (2), the unit cranks the starter for the programmed time and then attempts to sense that the engine is running by detecting an increase in volt-

age. If programmed OFF (3) the vehicle cranks for the programmed crank time (feature 3-3) and does not verify with tach or voltage that the car is running. In the OFF setting, if the vehicle fails to start, the ignition can stay on for the entire run duration. When set to Tachometer (4), the unit references the learned tach signal to disengage the starter. In addition it monitors the RPM and shut down if the engine RPM is too high or too low.

**Note:** The tach wire must be connected and programmed for the manual transmission mode to work.

**3-3 Crank Time 0.6 (1) 0.8 (2) 1.0 (3) 1.2 (4) 1.4 (5) 1.6 (6) 1.8 (7) 2.0 (8) 4.0 (9) SECONDS:** If the unit is programmed for no engine checking or voltage sense, the crank time must be set to the appropriate duration. The default setting is 0.6 second and the LED flashes once. If a different crank time is desired, toggle through the higher settings by using the two-chirp settings.

**3-4 Run Time 12 (1), 24 (2) 60 (3) MINUTES:**  Selects the time in minutes that the system operates the engine until the system “times out”. The system may be shut down using the remote or any of the shutdowns at any time. Using the Bitwriter®, the run time can be programmed for any duration from 1-60 minutes.

**3-5 Activation Pulse One (1):** Two activation pulses (2). This allows the system to use 1 or 2 pulses to activate the remote start sequence.

**Note:** This setting affects both the input wire and the remote control.

**3-6 Turbo Mode: OFF (1).** On 1 min (2), On 3 min (3) On 5 min (4) On 10 min (5): In the Off setting the turbo mode does not function. In the On and timed setting, the remote start can be used as a turbo timer. The car remains running for the programmed runtime, and the ignition is turned Off.

**Note:** For this feature to work the “turbo timer run time” mode needs to be programmed ON and the tachometer wire on the remote start needs to be connected and programmed.

**3-7 Timer Mode Run Time—12min (1), 3(2), 6 (3), 9 (4) MINUTES:**  Selects the time in minutes that the system operates the engine until the system

"times out" when the remote start activates in timer mode. The system may be shut down using a shutdown at any time. Using the Bitwriter®, the run time can be programmed for any duration from 1-16 minutes.

**3-8 Flex Relay Function: Ignition 2 (1)** In the factory setting, the flex relay functions the same as the pink ignition 1 wire, in accessory (2) setting the flex relay functions the same as the Orange accessory 1 wire, in starter (3) setting the flex relay functions the same as the purple starter 1 wire.

**3-9 Diesel Timer—Wait-To-Start Input (1)** 15 (2), 30 (3), or 45 (4) seconds.

 Default is the "Wait-to-Start" input control wire, or programmable to ignore the input control wire by a delay of 15 ,30, or 45 seconds. This feature can also be optionally programmed with the Bitwriter®, with a delay from 1 to 90 seconds in one second increments.

**3-10 Accessory State During Wait-To-Start: On (1) OFF (2):** This feature allows the selection of the accessory output to be ON or OFF during wait-to-start. Use the two-chirp setting for OFF.

**3-11 2nd Status Output: Normal (1) Latched (2) Pulsed (3):** This feature allows selection of status output or a rear defogger mode that turns on ten seconds after the vehicle has started if the vehicle interior temperature is below 55 degrees F. The defogger mode has two selections, latched, or pulsed. Latched mode only stays on for 10 minutes.

**Note:** When the defogger mode is on, the output is always active and can be turned on independently with the remote for a one-time activation. (See the Remote Functions table.)

**3-12 Parking Lights: Constant (1) Flashing (2) OFF (3):** In the default setting, the parking lights (if connected) comes on solid during the remote start runtime. In the two- flash setting the parking lights flashes during the remote start runtime. In the OFF setting, the parking lights do not come ON or flash, when the vehicle is remote started.

**3-13 Anti-Grind: On (1) OFF (2):** With the anti-grind On (default) the ground-when-armed output is active during remote start operation. This activates the starter kill relay and prevents the customer from re-cranking the car with the key, when doing key takeover. If accessories such as a voice module or window

module are added to the unit, it may be necessary to use the two-chirp setting to program this feature OFF.

**3-14 Tach Mode Starter Release: Normal (1)** Increase (2) Decrease (3): Use the two-chirp setting to increase time by 15% of the original tach programmed time. Use the three chirp setting to decrease by 15% of the original programmed time.

**3-15 Vehicle temperature auto report: ON (1)** or OFF (2). The default setting is OFF. When programmed ON the main unit stores the interior temperature of the vehicle in its temporary memory. When the vehicle's interior temperature changes 1 degree Celsius, the main unit automatically sends the interior temperature message to the remote the screen displays the current temperature.

## ➤ Bitwriter®



The Bitwriter®  has the ability to fine tune certain features of the security system. These features and the adjustments that may be programmed are described in the table below.

Feature	Default setting	Optional settings
Zone 4 sensor icon	None	Shock/omni, field disturbance, tilt sensor, glass break, ultrasonic
Aux/trunk icon type	Trunk	Window, sunroof, audio, lights, left slider dr, right slider dr, rear hatch.
Aux 1 timed output	30 seconds	1-90 seconds
Aux 1 icon type	Trunk	Window, sunroof, audio, lights, left slider dr, right slider dr, rear hatch, timed, latched, pulsed
Aux 2 timed output	30 seconds	1-90 seconds
Aux 2 icon type	Trunk	Window, sunroof, audio, lights, left slider dr, right slider dr, rear hatch, timed, latched, pulsed
Aux 3 timed output	30 seconds	1-90 seconds
Aux 3 icon type	Trunk	Window, sunroof, audio, lights, left slider dr, right slider dr, rear hatch, timed, latched, pulsed
Diesel start timer	15 seconds	1-90 seconds
Timer mode run time	12 minutes	1-16 minutes
Timer mode starts	6 starts	1/2/3/4/ <b>6</b> /8/10/12/14/16/18 20/22/24 (Starts)
Timer mode intervals	3 hours	1/2/ <b>3</b> /4/6/8/10/12/14/16/18/ 20/22/24 (Hours)
Smart start low temp	0 (F)	OFF/-20/-10/ <b>0</b> /10/20/30/40/50 /60/70 (F)
Smart start high temp	100 (F)	OFF/40/50/60/70/80/90/ <b>100</b> / 110/120/130 (F)

Feature	Default setting	Optional settings
Smart start low battery	10.5 volts	OFF/12.5/12/11.5/11/ <b>10.5</b> /10/ 9.5/9 volts
Sensor 1 level	7 (normal)	0/1/2/3/4/5/6/ <b>7</b> /8/9/10/11/1 2/13/14/15
Tach mode starter release	10 (normal)	0/1/2/3/4/5/6/7/8/9/ <b>10</b> /11/1 2/13/14/15/16/17/18/ 19/20
Feature programming	Unlocked	Locked
Virtual tach fine tune	Not initialized	0 to 1 second in 50ms increments.
Transmitter programming	Unlocked	Locked
Remote start runtime	12 minutes	1-60 minutes

## Long term event history

---

The system stores the last two full triggers in memory. These are not erasable. Each time the unit sees a full trigger, the older of the two triggers in memory is replaced by the new trigger. To access long term event history:

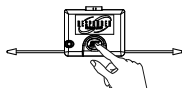

1. With the ignition off, press and hold the Valet/Program switch.



2. Turn on the ignition.

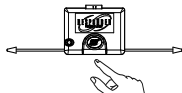

3. Release the Valet/Program switch.

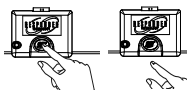

4. Press and release the Valet/Program switch within 5 seconds. The LED flashes in groups indicating the last two zones that triggered the unit for one minute or until the ignition is turned off. Refer to table of zones.

**Note:** The Warn Away triggers are not stored to memory and is not reported.

## Table of zones

---

When using the Diagnostic functions, use the Table of Zones to see which input has triggered the system. It is also helpful in deciding which input to use when connecting optional sensors and switches.

<b>ZONE NO.</b>	<b>TRIGGER TYPE</b>	<b>INPUT DESCRIPTION</b>
1	Trunk Input	BLUE (H1/7)
2	Shock Sensor	Onboard shock sensor
3	Door Trigger	GREEN (H1/8) and VIOLET (H1/6).
4	Sensor 2	Optional MUX sensor port
5	Ignition	Heavy gauge pink of remote start harness
6	Hood Trigger	GRAY on the 6-pin shutdown harness.

**Note:** The WarnAway® response does not report on the LED

## Shutdown diagnostics

---

To perform shutdown diagnostics:

1. With the ignition OFF, press and hold the Valet/Program switch.
2. Turn the ignition ON and then back OFF while holding the Valet/Program switch.
3. Release the Valet/Program switch.
4. Press and release the Valet/Program switch. The LED flashes to report the last shutdown for one minute or until the ignition is turned on, as shown in the following table:

### LED Flashes

- 1 flash
- 2 flashes
- 3 flashes
- 4 flashes
- 5 flashes
- 6 flashes

### Shutdown Mode

- Runtime expired
- Over-rev shutdown
- Low or no RPM
- Transmitter shutdown (or optional push button)
- (+) Brake shutdown
- (-) Hood shutdown



7 flashes	Timer mode/Turbo mode/Manual mode error *
8 flashes	Neutral safety shutdown
9 flashes	Low battery (voltage mode)
10 flashes	Alarm triggered **
11 flashes	Wait-to-start input timed out

\* Timer mode error: Ignition is on or shutdown input is active when activating timer mode.

Turbo mode error: Turbo mode is programmed off, engine is not on or shutdown input is active.

Manual mode error: MTS mode not enabled.

\*\* Alarm was triggered during remote start sequence.

## Remote starting diagnostics

---

When the remote start function is activated and the 2-way remote emits an error tone; you have the ability to see what the cause of the no-start situation is by counting the amount of flashes of the parking lights from the vehicle.

5 flashes	Brake wire is active
6 flashes	Hoodpin wire is active
7 flashes	Manual transmission mode is enabled and not initialized.
8 flashes	Neutral safety wire has no ground or the neutral safety switch is Off.

## Remote start safety check

---

Before vehicle reassembly, the remote system must be checked to ensure safe and trouble-free operation. The following test procedure must be used to verify proper installation and operation of the system. The installation must be completed before testing, including connection to the brake switch and hood switch.

1. Test the BRAKE shutdown circuit: With the vehicle in Park (P), activate the remote start system. Once the engine is running, press the brake pedal. The engine should shut down immediately. If the engine continues to run, check the brake circuit connection.
2. Test the HOOD PIN shutdown circuit: With the vehicle in Park (P), open the hood. Activate the remote start system. The vehicle should not start. If the starter engages, check your hood pin and connections.
3. Test the NEUTRAL SAFETY shutdown circuit.

<p><b>Important!</b> Make sure there is adequate clearance to the front and rear of the vehicle before attempting this test.</p>
--

1. Make sure the hood is closed and no other shutdown circuits are active.
  2. Set the emergency brake.
  3. Turn the ignition key to the run position but do not start the engine.
  4. Put the vehicle in Drive (D).
  5. Put your foot over the brake pedal but do not press down on it. Be ready to step on the brake to shutdown the remote start system.
  6. Activate the remote start system.
- If the starter engages, immediately step on the brake to shut down the system. If it does engage, recheck the neutral safety input connection. The vehicle may use a mechanical neutral safety switch. (See H3/1 BLACK/WHITE neutral safety switch input in Remote Start Harness Wire Connection Guide section of this guide.)
  - If the starter does not engage, the test is complete. Once the system passes the tests, the vehicle can be re-assembled and delivered. Do not use the remote start system or finalize the installation if it fails any of the safety check tests.

# Troubleshooting

---

## ➤ Alarm

- **Shock sensor doesn't trigger the alarm:**

Has the NPCC® system been triggered? If so, you hear 5 chirps when disarming. To check this, turn the ignition key on and off to clear the NPCC® memory, and then retest the shock sensor. For a detailed description of NPCC®, see Nuisance Prevention Circuitry section of the owners guide.

- **Door input does not immediately trigger full alarm. Instead, chirps are heard for the first 3 seconds:**

That's how the progressive two-stage door input works! This is a feature of this system. This is an instant trigger, remember, even if the door is instantly closed again, the progression from chirps to constant siren continues.

- **Closing the door triggers the system, but opening the door does not:**

Have you correctly identified the type of door switch system? This happens often when the wrong door input has been used. (See Door Lock Harness Wire Connection Guide section of this guide.)

- **System does not passively arm until it is remotely armed and then disarmed:**

Are the door inputs connected? Is the H1/6 blue wire connected to the door trigger wire in the vehicle? Either the H1/5 green or the H1/7 violet should be used instead. (See wiring diagrams.)

- **Door input does not respond with the progressive trigger, but with immediate full alarm:**

Does the Status LED indicate that the trigger was caused by the shock sensor? (See Diagnostics section of this guide.) The shock sensor, if set to extreme sensitivity, may be detecting the door unlatching before the door switch sends its signal. Reducing the sensitivity can solve this problem.

- **The Valet/Program switch doesn't work.**

Is it plugged into the correct socket? See Plug-In LED and Valet/Program Switch

section of this guide.

- **Status LED doesn't work.**

Is it plugged in? (See Plug-In LED and Valet/Program Switch section of this guide.) Is the LED plugged into the correct socket?

- **Door locks operate backwards.**

This unit has easily-reversed lock/unlock outputs. Recheck wire connections to see if you have reversed these.

## ➤ Remote start

- **The remote start does not activate**

1. Check remote startup diagnostics to determine what may be the cause of the no start situation.
2. Check the harnesses and their connections. Make sure that the harnesses are completely plugged into the remote start module. Make sure there are good connections to the vehicle wiring.
3. Check voltage and fuses on the main 12-pin harness and on the
4. Heavy gauge remote start harness.

- **The remote start does activate, but the starter never engages.**

1. Check for voltage on the purple starter wire two seconds after the remote start becomes active. If there is voltage present, skip to Step 4. If there is not voltage present, advance to Step 2.
2. Check the 30A fuses.
3. If the gray/black wait-to-start wire is detecting ground upon activation, the starter will not crank.
4. Make sure the purple starter wire is connected on the starter side of the optional starter kill/anti-grind relay.
5. Does the vehicle have an immobilizer? Some immobilizer systems do not allow the vehicle to crank if active.
6. Check connections. The heavy gauge remote start input wires on the heavy gauge 10-pin connector should have a solid connection. "T-taps" or "scotch locks" are not recommended for any high current heavy gauge wiring.

- **The vehicle starts, but immediately dies.**
  1. Does the vehicle have an immobilizer? The vehicle's immobilizer cuts the fuel and/or spark during unauthorized starting attempts.
  2. Is the remote start programmed for virtual tach or voltage sense? If so, the crank time may not be set high enough. Voltage sense does not work on some vehicles.
  3. Check diagnostics. Sometimes a shutdown becomes active during cranking or just after cranking.
  
- **The vehicle starts, but the starter keeps running.**
  1. Is the system programmed for engine checking off or virtual tach voltage sense? When programmed for either of these features, the engine cranks for the preprogrammed crank time regardless of how long it takes for the vehicle to actually start. Adjust to a lower cranking time.
  2. Was the Tach Learn successful? The LED must light solid and bright to indicate a successful learn.
  3. Make sure that there is a tach signal at the purple/white tach input wire of the remote start. If there is not a tach signal, recheck the connection to the vehicle's tach wire and make sure the wire is not broken or shorted to ground leading to the remote start.
  
- **The vehicle starts, but only runs for 10 seconds.**
  1. Is the remote start programmed for voltage sense? If this does not work, a tach wire should be used.
  2. Check shutdown diagnostics.
- **The climate control system does not work while the unit is operating the vehicle.**

Either the wrong accessory wire is being energized or more than one ignition or accessory wire must be energized in order to operate the climate control system.

- **Remote start MTS mode failure**

The remote emits a failure notification when trying to enable the manual transmission mode or the vehicle fails to stay remote started when the key is turned off. Possible causes are:

- Hood Open (gray wire).
- Foot Brake active (brown wire).

- No Parking Brake input, Black/white neutral safety wire not showing ground with parking brake set.
- Tachometer is not hooked up or programmed.
- The unit has not been programmed for tachometer mode
- Toggle switch not installed or not in the ON position.



Designed and Engineered in the USA

***Directed***<sup>®</sup>  
E L E C T R O N I C S

N5702X 2008-08

Vista, CA 92081

[www.directed.com](http://www.directed.com)

© 2008 Directed Electronics.—All rights reserved.