

CLIFFORD®

Installation Guide

IntelliGuard 770



***IMPORTANT!** Please note that this manual was intended for US consumers and therefore includes American phrases or words.*

Bitwriter™, Code Hopping™, Directed®, Doubleguard®, ESP™, FailSafe®, Ghost Switch™, Learn Routine™, Nite-Lite®, Nuisance Prevention Circuitry®, NPC®, Revenger®, Silent Mode™, Soft Chirp®, Stinger®, Valet®, Vehicle Recovery System®, VRS®, and Warn Away® are all Trademarks or Registered Trademarks of Directed Electronics, Inc., Vista, California.

contents

warning! safety first	1
before beginning the installation	2
after the installation	2
transmitter functions	3
standard configuration	3
primary harness wire connection guide	4
primary harness wiring diagram	4
primary harness wiring guide . .	5
secondary harness wire connection guide	8
secondary harness wiring diagram	8
secondary harness wiring guide	8
immobilizer harness wire connection guide	9
immobilizer harness wiring . . .	9
ultrasecure immobilizer	10
immobilizer jumper setting . . .	10
door lock harness wire connection guide	10
type A: positive (+) 12-volt pulse .	11
type B: negative (-) pulse	12
type C: reversing polarity	13
type D: after-market actuators	14
type E: mercedes-benz and audi (1985 & newer)	15
type F: one-wire system	16
type G: positive (+) multiplex .	17
type H: negative (-) multiplex .	18
peripheral plug-in harnesses . . .	19
super bright blue led, 2-pin white plug	19
plain-view valet	19
sensor harness, 4-pin connector .	19
mounting the receiver/antenna	20
arming/disarming diagnostics . .	21
arming	21
disarming	21
system status chirps	22
remote siren silencing	22
multiple event total recall	22
table of zones	22
system features programming . .	23
cliffnet wizard pro installation	23
software programming	23
manual programming instructions	24
user selectable features	25
user selectable features descriptions - column one	26
user selectable features descriptions - column two	27
user selectable features descriptions - column three	28
installer selectable features . .	30
installer selectable features descriptions - column one	31
installer selectable features descriptions - column two	32
installer selectable features descriptions - column three	33
programming notes	34
fact II - false alarm control technology	36
smart power up II	37
remote control sensor disable . .	37
mux sensors	37
audio sensor	37
adjusting the audio sensor . . .	37
auto-immobilization feature . . .	38
auto-immobilization sequence	38
one-time valet feature	38
blackjax feature	39
blackjax activation sequence . .	39
blackjax deactivation sequence	40
bypass blackjax temporarily (if on in program grid)	40
remote adjustable omnisensor .	40
installing the omnisensor	40
adjusting the omnisensor	40
second unlock feature	42
troubleshooting	42
wiring reference guide	44
notes	48

warning! safety first

The following safety warnings must be observed at all times:

- Due to the complexity of this system, installation of this product must only be performed by an authorized Clifford dealer.
- When properly installed, this system can start the vehicle via a command signal from the remote control transmitter. Therefore, never operate the system in an area that does not have adequate ventilation. The following precautions are the sole responsibility of the user; however, authorized Clifford dealers should make the following recommendations to all users of this system:
 1. Never operate the system in an enclosed or partially enclosed area without ventilation (such as a garage).
 2. When parking in an enclosed or partially enclosed area or when having the vehicle serviced, the remote start system must be disabled using the installed toggle switch.
 3. It is the user's sole responsibility to properly handle and keep out of reach from children all remote control transmitters to assure that the system does not unintentionally remote start the vehicle.
 4. THE USER MUST INSTALL A CARBON MONOXIDE DETECTOR IN OR ABOUT THE LIVING AREA ADJACENT TO THE VEHICLE. ALL DOORS LEADING FROM ADJACENT LIVING AREAS TO THE ENCLOSED OR PARTIALLY ENCLOSED VEHICLE STORAGE AREA MUST AT ALL TIMES REMAIN CLOSED.
- Use of this product in a manner contrary to its intended mode of operation may result in property damage, personal injury, or death. Except when performing the Safety Check outlined in this installation guide, (1) Never remotely start the vehicle with the vehicle in gear, and (2) Never remotely start the vehicle with the keys in the ignition. The user will be responsible for having the neutral safety feature of the vehicle periodically checked, wherein the vehicle must not remotely start while the car is in gear. This testing should be performed by an authorized Clifford dealer in accordance with the Safety Check outlined in this product installation guide. If the vehicle starts in gear, cease remote start operation immediately and consult with the user to fix the problem immediately.
- After the remote start module has been installed, test the remote start module in accordance with the Safety Check outlined in this installation guide. If the vehicle starts when performing the Neutral Safety Shutdown Circuit test, the remote start unit has not been properly installed. The remote start module must be removed or properly reinstalled so that the vehicle does not start in gear. All installations must be performed by an authorized Clifford dealer.

OPERATION OF THE REMOTE START MODULE IF THE VEHICLE STARTS IN GEAR IS CONTRARY TO ITS INTENDED MODE OF OPERATION. OPERATING THE REMOTE START SYSTEM UNDER THESE CONDITIONS MAY RESULT IN PROPERTY DAMAGE OR PERSONAL INJURY. IMMEDIATELY CEASE THE USE OF THE UNIT AND REPAIR OR DISCONNECT THE INSTALLED REMOTE START MODULE. CLIFFORD WILL NOT BE HELD RESPONSIBLE OR PAY FOR INSTALLATION OR REINSTALLATION COSTS.

before beginning the installation

WARNING! This system is intended for automatic transmission, fuel-injected vehicles only. Installation in a standard transmission vehicle maybe dangerous and is contrary to its intended use.

- Please read this entire installation guide before beginning the installation. The installation of this remote start system requires interfacing with many of the vehicle's systems. Many new vehicles use low-voltage or multiplexed systems that can be damaged by low resistance testing devices, such as test lights and logic probes (computer safe test lights). Test all circuits with a high quality digital multi-meter before making connections.
- Do not disconnect the battery if the vehicle has an anti-theft-coded radio. If equipped with an air bag, avoid disconnecting the battery if possible. Many airbag systems will display a diagnostic code through their warning lights after they lose power. Disconnecting the battery requires this code to be erased, which can require a trip to the dealer.
- Remove the domelight fuse. This prevents accidentally draining the battery.
- Roll down a window to avoid being locked out of the car.

after the installation

- Test all functions. Refer to the "Using Your System" section of the Owner's Guide when testing.
- Complete the vehicle Safety Check outlined in this manual prior to reassembly.

transmitter functions

This system uses computer-based code learning to learn the transmitter buttons. This makes it possible to assign any transmitter button to any system function. The transmitter initially comes programmed with standard configuration, but may also be customized by an authorized dealer. The buttons in all of the instructions in this manual correspond to a standard configuration transmitter.

standard configuration

 Button

The arming, disarming, and panic function are controlled by this button.

 Button



The trunk release or accessory output A is controlled by this button.

 Button



Remote start is controlled by this button.

 Button



Silent arm and disarm is controlled by this button.

 Button, then  Button



Accessory B output is controlled by these buttons.

 Button, then  Button



These buttons activate SmartWindows.

 Button, then  Button



Accessory C output is controlled by these buttons.

 Button twice, then  Button

These buttons activate remote valet.

 Button twice, then  Button

These buttons disable the sensors.

 Button twice, then  Button

These buttons enter safe start mode for manual transmission vehicles and activate Autostart mode.

 Button three times, then  Button

These buttons adjust the optional dual-zone radar sensor.

 Button three times, then  Button

These buttons adjust the dual-zone omnisensor.

primary harness wire connection guide

primary harness wiring diagram

H1/1	BLACK	Ground
H1/2	BROWN	Speaker Output 1
H1/3	GRAY	(-) Hood Trigger Input Zone 6
H1/4	VIOLET/BLACK	Tach Input
H1/5	GREEN/WHITE	(-) Normally Closed Input - Zone 6
H1/6	WHITE/BLUE	(-) Accessory B Output (200mA)
H1/7	BLUE	(-) Trunk Trigger Input - Zone 5
H1/8	VIOLET	(+) Door Trigger Input - Zone 4
H1/9	GREEN	(-) Door Trigger Input - Zone 4
H1/10	RED	(+) 12V Constant
H1/11	BROWN	Speaker Output 2
H1/12	WHITE/RED	Light Flash Input
H1/13	WHITE	Light Flash Output
H1/14	WHITE	Light Flash Output
H1/15	BLACK/WHITE	Dome Light Supervision Output 30
H1/16	RED/WHITE	(-) Accessory Output A (200mA)
H1/17	ORANGE	Ground When Armed (500mA)
H1/18	EMPTY	Not Used

primary harness wiring guide

This guide describes in detail the connection of each wire. Also included are possible applications of each wire. This system was designed with the ultimate in flexibility and security in mind. Many of the wires have more than one possible function. Please read the instructions carefully to ensure a thorough understanding of this unit and how it operates.

h1/1 black ground

Connect the BLACK wire to a clean, paint-free sheet metal location (driver's kick panel) using a factory bolt that does NOT have any vehicle component grounds attached to it. A screw should only be used in conjunction with a two-sided lock washer. Under dash brackets and door sheet metal are not acceptable ground points. It is recommended that all security components be grounded at the same location.

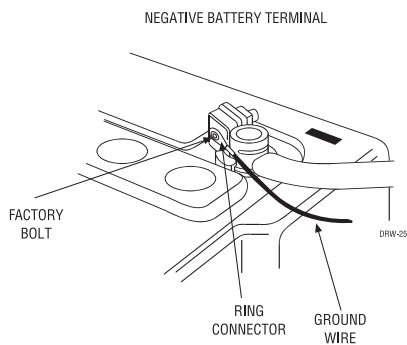
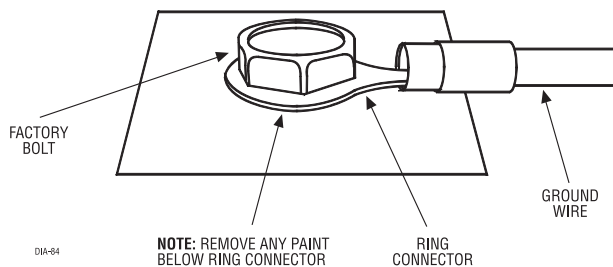

h1/2 and h1/11 brown speaker outputs

Connect the BROWN output wires to the BROWN wires of the 518C.

h1/3 gray (-) hood input zone 6

Connect this wire to the hood pin. If the hood is open when the alarm is armed, this wire will trigger the siren.

h1/4 violet/black tach input

This wire monitors engine speed for BlackJax and door locks. Connect it to the negative side of the coil or to the uncommon color of any fuel injector. If installing with Intellistart, only connect the Intellistart wire; DO NOT use this wire.

h1/5 green/white (-) normally closed zone 6

This wire will trigger the alarm if it loses its normally closed ground. Remove this wire from the ground wire and attach it to a normally grounded item you wish to protect such as the back of your stereo.

h1/6 white/blue (-) accessory b output (200mA)

This wire produces a 200mA output when activated by the remote control and can be used to operate a variety of accessories. All accessory outputs can be programmed to different types of outputs. Please see Programming Note #6.

h1/7 blue (-) trunk trigger input - zone 5

This input will respond to a negative input with an instant trigger. Connect to (-) trunk pins and it will report on Zone 5. It can also be used with Directed single-stage sensors.

h1/8 violet (+) door trigger input - zone 4

Connect the violet wire to a wire that shows (+)12V when any door is opened. This wire will report Zone 4.

h1/9 green (-) door trigger input - zone 4

Most vehicles use negative door trigger circuits. Connect the GREEN wire to a wire showing ground when any door is opened. When connecting to newer model vehicles there is generally a need to use individual door triggers. This wire will report Zone 4.

NOTE: If using a door trigger wire that has a delay, the installer-selectable programming grid or the Cliffnet Wizard can be used to turn the door ajar warning off.

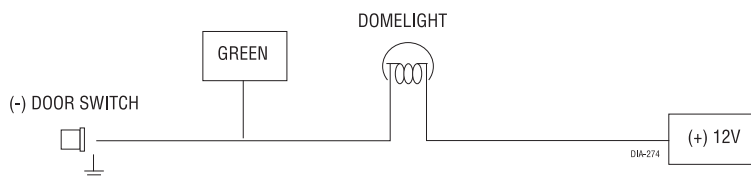

h1/10 red (+) 12v constant

Before connecting the RED wire, remove the supplied fuse. Connect to the battery positive terminal (be sure to use the supplied fuse holder and a 5 amp fuse) or the constant (+) 12V supply to the vehicle fusebox.

h1/12 white/red light flash input

This wire is the input for the on-board dual light flash relay. If the vehicle has positive parking light activation wires, connect this wire to a constant (+) 12V source that is fused at 15A or higher (be sure to use the supplied fuse holder and a 15 amp fuse). If the vehicle parking light activation wire is negative, connect this wire to a chassis ground location.

h1/13 and h1/14 white parking light output

These wires are the output of an on-board dual make relay and should be connected to wires in the vehicle that control the parking light wire polarity. The dual outputs are designed for European vehicles with isolated parking light systems. If the vehicle's parking lights are controlled by a single wire, connect both WHITE wires to it.

IMPORTANT! The polarity of this wire is determined by the connection of the H1/12 light flash input wire. Always confirm light flash polarity before connecting H1/12 or damage to the vehicle lighting system could occur.

h1/15 black/white dome light supervision output

Connect the H1/15 BLACK/WHITE wire to the vehicle domelight circuit trigger wire.

h1/16 red/white accessory a output

When the system receives the code controlling the accessory output, this wire will supply an output as long as the transmission continues. This is often used to operate a trunk/hatch release or other relay-driven function. All accessory outputs can be programmed to different types of outputs. Please see Programming Note #6.

IMPORTANT! Never use this wire to drive anything but a relay or a low-current input! The transistorized output can only supply 200 mA of current. Connecting directly to a solenoid, motor, or other high-current device will cause it to fail.

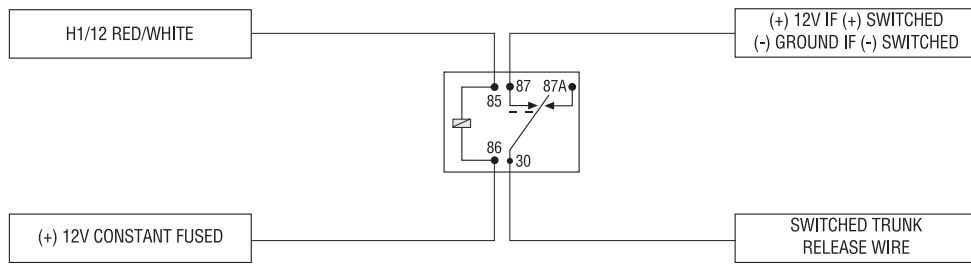

h1/17 orange ground when armed

This wire provides a (-) ground output as long as the system is armed and will cease when the system is disarmed. This output can be used for an additional immobilizer relay or to control additional accessories such as window automation, voice modules, or pagers.

secondary harness wire connection guide

secondary harness wiring diagram

H2/1	YELLOW/WHITE	(-) Horn Honk Output (200 mA)
H2/2	PINK/BLACK	(-) Accessory Output C (200 mA)
H2/3	BLACK/WHITE	Domelight Supervision Input (87)
H2/4	BROWN/RED	Brake Light (+) 12V Input
H2/5	BROWN/WHITE	Brake Light Output
H2/6	BLUE/WHITE	Second Unlock Output (200 mA)

secondary harness wiring guide

h2/1 yellow/white (-) horn honk output (200mA)

This wire is a low current output (200mA) for the horn to sound when the system has been violated.

h2/2 pink/black (-) accessory output C (200mA)

This wire produces a 200mA output when activated by the remote control and can be used to operate a variety of accessories. All accessory outputs can be programmed to different types of outputs. Please see Programming Note #6.

h2/3 black/white domelight supervision input (87)

This wire determines the output of the BLACK/WHITE H1/15 wire on the main 18-pin harness. If the vehicle has a negative domelight circuit, ground this wire; if the vehicle has a positive domelight circuit, attach this wire to a 12 volt constant source.

h2/4 brown/red brake light (+) 12V input

This is the polarity source for the brake light output and must be 12 volt constant.

h2/5 brown/white brake light output

This wire powers the brake light circuit with the 12 volt circuit only on H2/10 when activated.

h2/6 blue/white second unlock output (200mA)

This wire produces a (-) 200mA output for progressive locks in which the driver door unlocks first and the remaining locks unlock with a second press of the unlock button.

immobilizer harness wire connection guide

immobilizer harness wiring

Locate the ignition and starter wires using a multimeter. Cut the appropriate wire and attach the key side and car side wires to the corresponding wires on the four-pin immobilizer harness.

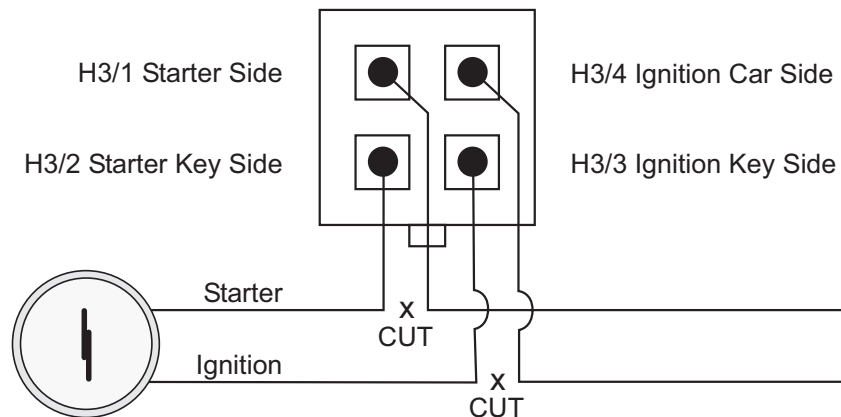

ultrasecure immobilizer

The UltraSecure immobilizer circuit in this G5 system is a unique new design that incorporates the immobilizer security of Clifford without the possibility of failure due to power loss that could potentially strand the user.

The level of security can be set by leaving in or removing the jumper located next to the immobilizer wires exiting the module.

immobilizer jumper setting

jumper in setting

When the jumper is in, the ignition and starter signal will bypass the UltraSecure immobilizer circuitry and allow the vehicle start and run, even if power has not been restored to the module.

jumper out setting

When the jumper is out, the UltraSecure immobilizer circuitry prevents the ignition and starter signal from passing and keeps the vehicle immobilized until power has been restored to the module.

NOTE: In order for the system to bypass the immobilizer with the jumper in place, the unit must have ground on the 18-pin harness.

door lock harness wire connection guide

H3/1	—	GREEN	(-) Lock, (+) Unlock Output
H3/2	—	EMPTY	(+) 12V Protected, Low Current for 451M
H3/3	—	BLUE	(-) Unlock, (+) Lock Output

IMPORTANT! The door lock outputs are low current and should not be attached directly to any high-current device; they are only to be used to activate relays.

type A: positive (+) 12-volt pulse

The system can control Type A door locks directly, with no additional parts. The switch will have three wires on it; one will test (+)12 volt constantly. The others will alternately pulse (+)12 volt when the switch is pressed to the lock or unlock position.

If you cannot get to the switch, and you find a set of wires that pulse (+)12 volt alternately on lock and unlock, make sure that it is not a Type C direct-wire system.

Cut the wire that pulses (+)12 volt on lock, and then operate the switch to unlock.

- If all doors unlock, the vehicle uses type A system.
- If you lose all door lock operation in both directions, you are operating the master switch in a Type C system.
- If you lose all door lock operation of one or more, but not all motors, and other doors still work, you have cut a wire leading directly to one or more motors. You must instead find the actual wires leading to the switch.

IMPORTANT! Remember that these wires' functions reverse between Type A and Type B.

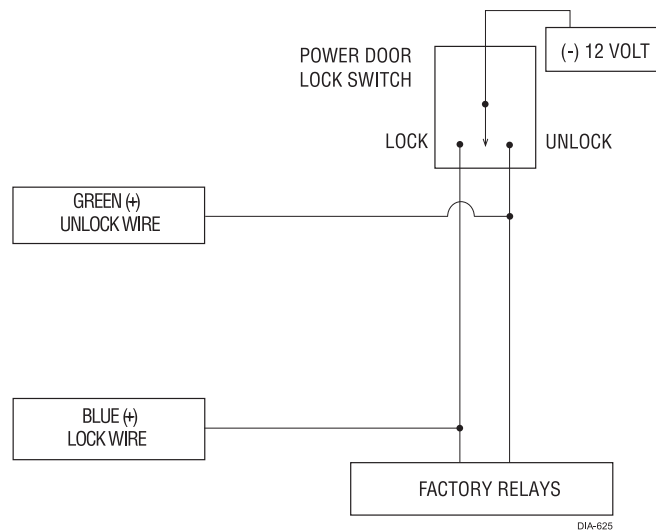

type B: negative (-) pulse

This system is common in many Toyotas, Nissans, Hondas, and Saturns, as well as Fords with keyless entry systems (some other Fords also use Type B). Most European Ford vehicles with (-) negative pulse locking are high current so a 451M or 2 relays need to be used.

The switch will have three wires on it, and one wire will test ground all the time. One wire will pulse negative (-) when the switch locks the doors, and the other wire will pulse negative (-) when the switch unlocks the doors. This type of system is difficult to mistake for any other type.

IMPORTANT! Remember that these wires' functions reverse between Type A and Type B.

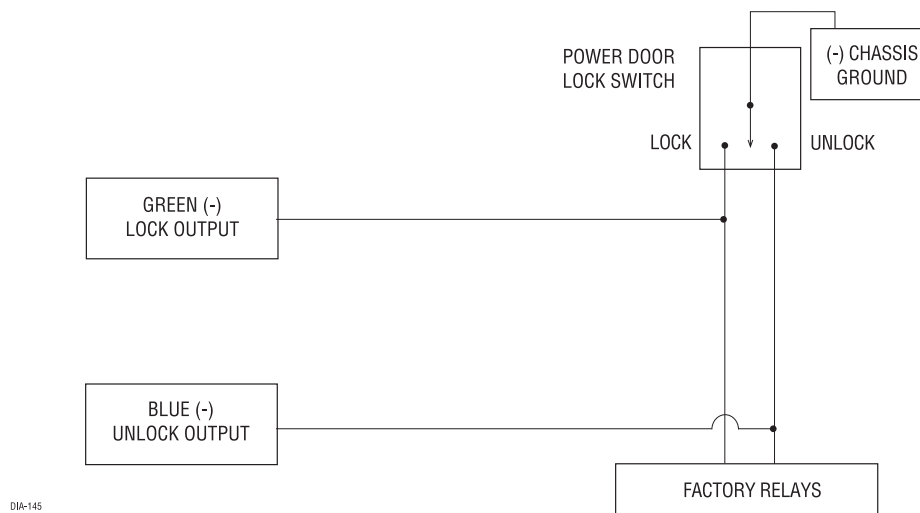

type C: reversing polarity

Interfacing with a reversing polarity system requires either two relays or one 451M (not included). It is critical to identify the proper wires and locate the master switch to interface the door locks properly. Locate wires that show voltage on lock and unlock. Cut one of the suspected wires and check operation of the locks from both switches. If one switch loses operation in both directions and the other switch operates in one direction only, you have located one of the target wires. The switch that lost all operation is the master switch. If one switch works in both directions and the other switch works in only one direction, you have a Type A system. If both switches still operate, but one or more doors has stopped responding entirely, you have cut a motor lead. Reconnect it and continue to test for another wire. Once both wires have been located and the master switch has been identified, cut both wires and interface as shown in the following diagram.

IMPORTANT! If these wires are not connected properly, you will send (+) 12 volt directly to (-) ground, possibly damaging the alarm or the factory switch.

IMPORTANT! Do not connect the outputs of the alarm directly to the actuator.

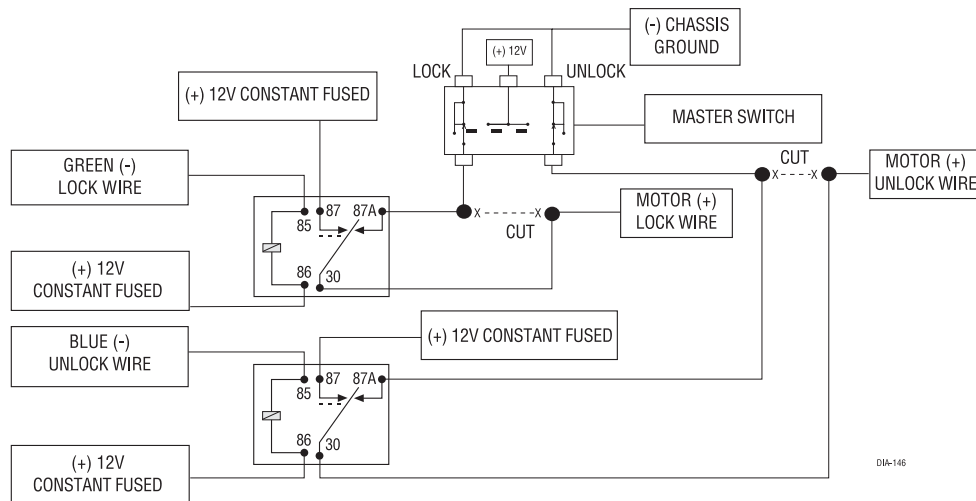

type D: after-market actuators

In order for this system to control one or more after-market actuators, a 451M or two relays (optional) are required. Vehicles without factory power door locks require the installation of one actuator per door. This requires mounting the door lock actuator inside the door. Other vehicles may only require one actuator installed in the driver's door if all door locks are operated when the driver's lock is used.

The fuse used on 12 volt inputs should be 7.5A per motor installed in the vehicle.

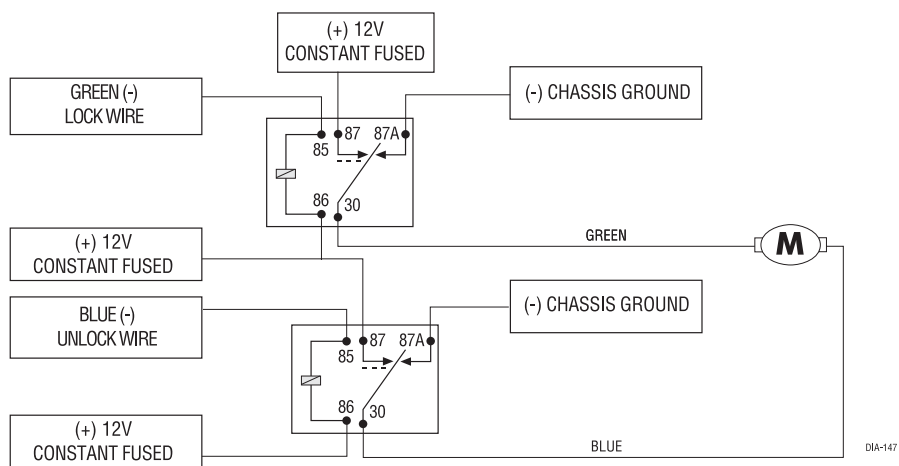

type E: mercedes-benz and audi (1985 & newer)

Type E door locks are controlled by an electrically activated vacuum pump. Some Mercedes and Audis use a Type D system. Test by locking doors from the passenger key cylinder. If all the doors lock, the vehicle's door lock system can be controlled with just two relays (optional). The control wire can be found in either kick panel and will show (+)12 volt when doors are unlocked and (-) ground when doors are locked.

To interface see diagram below. The system must be programmed for 3.5 second door lock pulses up to 1993 and 1 second pulse 1994 or newer.

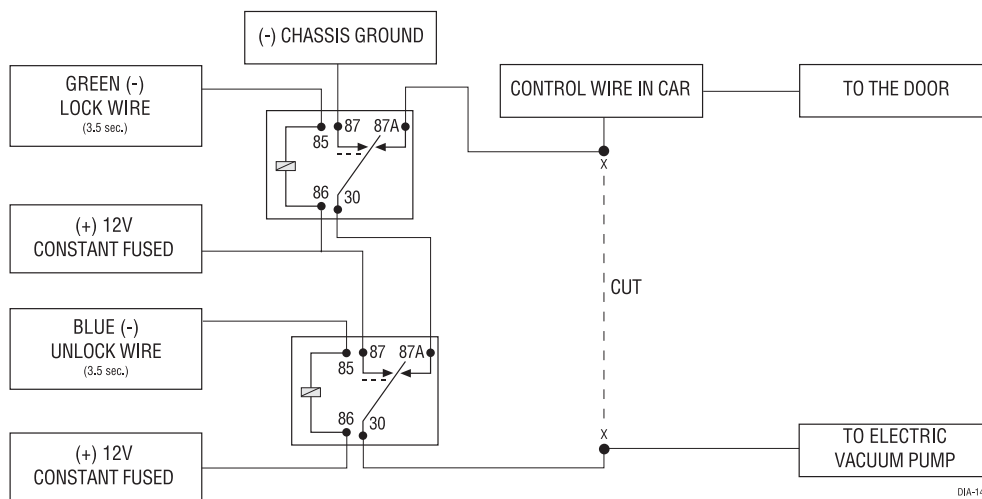

type F: one-wire system

Type F door locks usually require a negative pulse to unlock and cutting the wire to lock the door. In some vehicles, these functions are reversed. Type F door locks are found in late-model Nissan Sentras, some Nissan 240SX, and Nissan 300ZX 1992-up. They are also found in some Mazda MPVs, some Mitsubishi's, and Lotus.

One relay (optional) is used to interface to this type of system as follows:

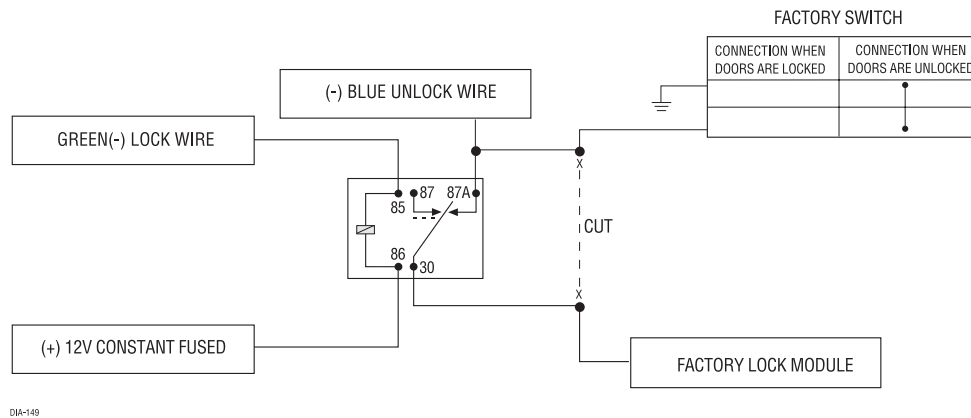

type G: positive (+) multiplex

The door lock switch or door key cylinder may contain either one or two resistors. When interfacing with this type of door lock system, two relays or a 451M must be used.

Single-Resistor Type

If one resistor is used in the door lock switch/key cylinder, the wire will pulse (+)12 volt in one direction and less than (+)12 volt when operated in the opposite direction.

Two-Resistor Type

If two resistors are used in the factory door lock switch/key cylinder, the switch/key cylinder will read less than (+)12 volt in both directions.

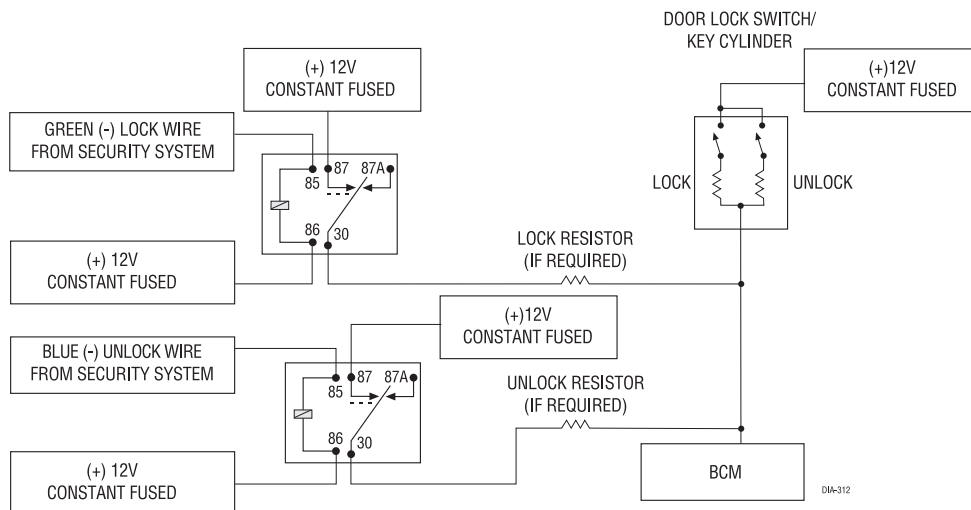

type H: negative (-) multiplex

The door lock switch or door key cylinder may contain either one or two resistors. When interfacing with this type of door lock system, two relays or a 451M must be used.

Single-Resistor Type

If one resistor is used in the door lock switch/key cylinder, the wire will pulse ground in one direction and resistance to ground when operated in the opposite direction.

Two-Resistor Type

If two resistors are used in the factory door lock switch/key cylinder, the door lock switch/key cylinder will read resistance to ground in both directions.

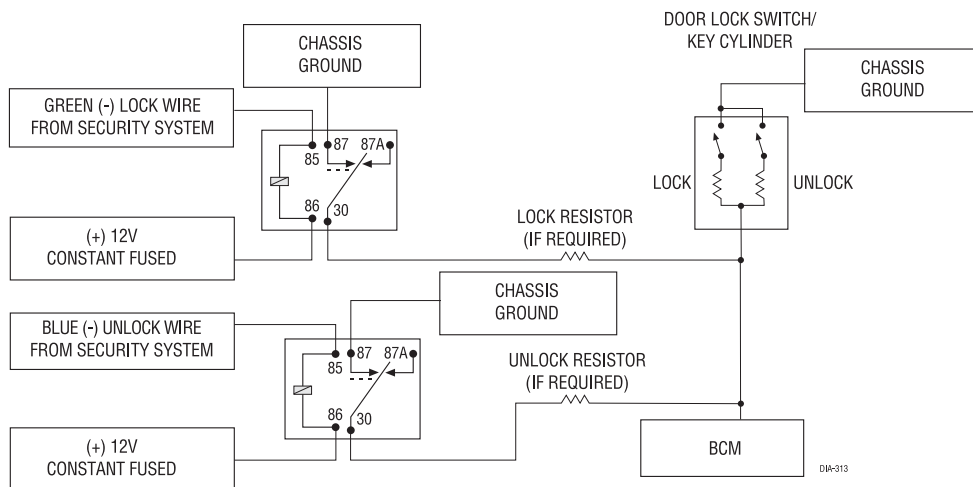

peripheral plug-in harnesses

super bright blue led, 2-pin white plug

The super bright LED operates at (+) 2V DC. Make sure the LED wires are not shorted to ground as the LED will be damaged. Multiple LEDs can be used, but they must be wired in series. The LED can be top-mounted or flush-mounted. If top-loading the LED with a bezel, the LED fits into a 5/16-inch mounting hole. If flush-mounting the LED from the back of a panel, drill a mounting hole using a 17/64-inch drill bit. Be sure to check for clearance prior to drilling the mounting hole.

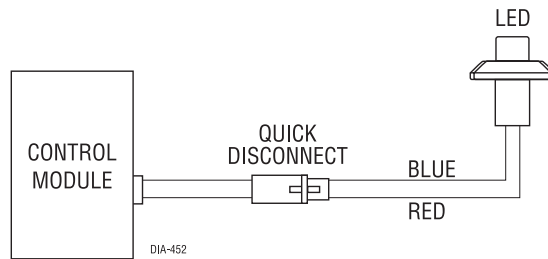

plain-view valet

The Valet/Program switch should be accessible from the driver's seat. It plugs into the blue port on the side of the unit. The switch is coded for protection so it need not be hidden. Consider how the switch will be used before choosing a mounting location. Check for rear clearance before drilling a 9/32-inch hole and mounting the switch.

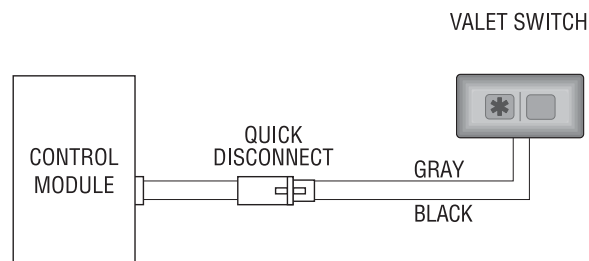

sensor harness, 4-pin connector

red and black wires

These wires supply 12 volts when the system is armed and ground to the sensor.

blue and orange wires, zone 3 zone 8

These wires are multiplex inputs. If a (-) input of less than 0.8 seconds is supplied to either wire, the Warning Zone response will occur. A (-) input of longer than 0.8 seconds to either wire will initiate the triggered sequence and report Zone 3 or Zone 8.

NOTE: For mounting and adjustment of sensors, please refer to the Mux Sensors section of this guide.

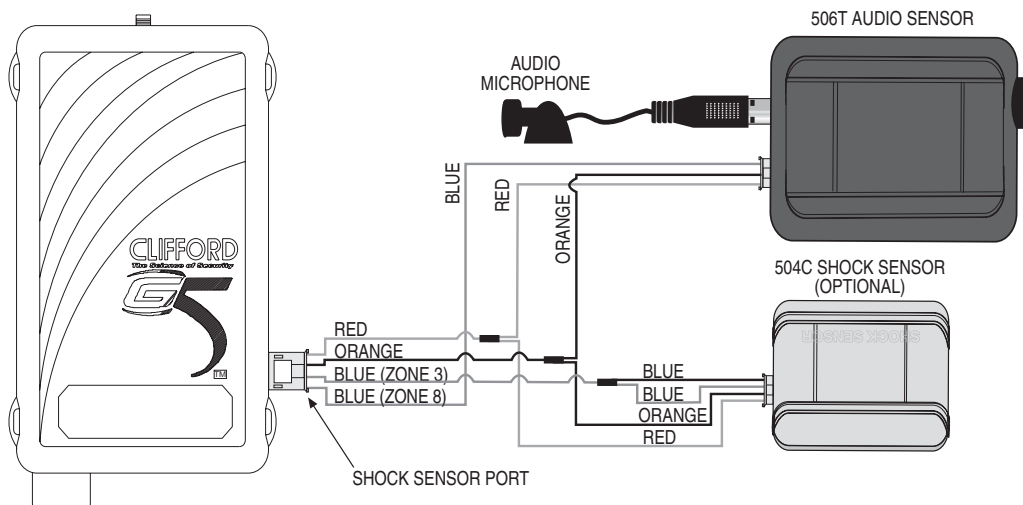

mounting the receiver/antenna

NOTE: Be sure not to bundle excess cable as this will reduce the range.

The receiver/antenna position should be discussed with the vehicle owner prior to installation since the antenna may be visible to the vehicle's operator.

The best position to locate the receiver/antenna is centered high on either the front or rear windshield. For optimal range, the antenna should be mounted vertically. It can be mounted horizontally in relation to the windshield or under the dashboard away from metal, but range will be reduced. Metallic window tint can also affect range, so this should be a consideration when determining the mounting location.

After determining the best mounting location, follow these steps:

1. Clean the mounting area with a quality glass cleaner or alcohol to remove any dirt or residue.
2. Plug the receiver/antenna cable into the receiver/antenna.
3. Mount the receiver/antenna with double-sided tape.
4. Route the receiver/antenna cable down the window pillar to the control module and plug the cable into the control module.

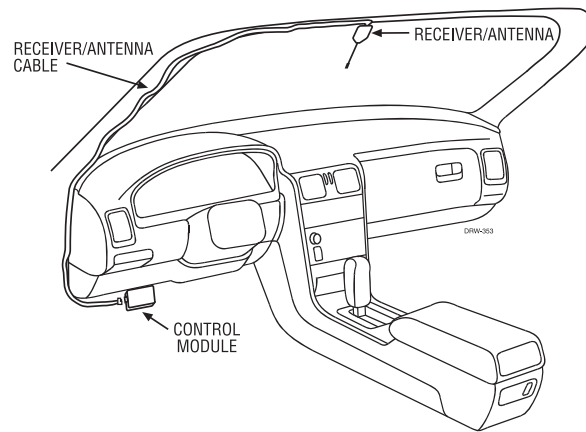

arming/disarming diagnostics

The systems microprocessor monitors and reports all active and violated zones when arming and disarming the system.

arming

Zones that are triggered at the time the system is armed are reported by an additional set of status chirps called Malfunction AutoBypass. The specific zone bypassed is then reported by the LED. For more zone information, refer to *Table of Zones* section of this guide.

disarming

If a zone is triggered, three disarm chirps will sound. The specific zone that was triggered is then reported by the LED when the ignition is turned on. For more zone information, refer to the *Table of Zones* section of this guide.

system status chirps

Action	No. of Chirps	Description
Arm	2	System armed.
Arm	4	System armed with hood or trunk bypass zones 5 and 6.
Arm	2 (5-second pause) 4	System armed with door bypass zone 4
Arm	2 (10-second pause) 4	System armed with sensor active and bypassed zones 1, 2, 3, and 8.
Disarm	1	System disarmed.
Disarm	3	System disarmed with zone violation

remote siren silencing

While the siren is sounding, press the arm/disarm button once to silence the siren but leave the system in the armed state. To disarm the system, press the arm/disarm button a second time.

NOTE: If the remote control battery is low, the siren will generate a single low pitched chirp when disarming.

multiple event total recall

This will report the last eight system triggers.



1. Press and hold  of the PlainView 2 Valet switch.
2. While still holding , arm and disarm the system, then release the button.
3. The LED will start to blink to indicate the most recent trigger and proceed down to the eighth trigger. If fewer than eight triggers are stored in memory, the LED will blink continuously until the system is armed/disarmed or the ignition is turned on. For more information, please refer to the Table of Zones section of this guide.

table of zones

When using the diagnostic functions, use the Table of Zones to see which input has triggered the system. It is also helpful in deciding which input to use when connecting optional sensors and switches.

NOTE: The Warning Zone response does not report on the LED.

LED Flashes	Trigger type	Input description
1	Data	Proximity Sensor
2	Data	Omnisensor
3	Mux 1	Sensor Input
4	Instant	Door Pin Input
5	Instant	Trunk Pin Input
6	Instant	Hood Pin Input
7	Instant	Ignition Input
8	Mux 2	Sensor Input
9	N/A	BlackJax Activation
10	N/A	Alarm power reset

system features programming

This system has many features that can be programmed to accommodate the user's personal preferences and make system installation easier. They are listed in two programming grids on the following pages. Many features have default settings that have been programmed at the factory and are indicated in bold type.

The User Selectable Features grid allows the user and installer to change operational features through the PlainView 2 Valet. The Installer Selectable Features grid allows the installer to change input/output functions of the system to integrate with the vehicle's specific characteristics.



cliffnet wizard pro installation software programming

Cliffnet Wizard Pro provides access to all available system features and some that are not available when manually programming with the Valet switch. Cliffnet Wizard Pro is compatible with Microsoft Windows 2000/ME/XP/NT so most programming operations can be accomplished by pointing and clicking with a mouse. This eliminates the need for programming grids and lengthy programming sequences. For a complete guide to system programming using the Cliffnet Wizard Pro refer to the Cliffnet Wizard help menu.



manual programming instructions

Be sure to document changes by taking note of all feature changes made in programming mode.

To enter the User Selectable Features programming:

1. Ignition on - Turn the ignition to the run position or start the engine.
2. Enter PIN - Enter the factory preset PIN code of 2 by pressing  on the PlainView 2 Valet switch twice, then  once.

NOTE: If the factory preset PIN has been changed, the new PIN must be entered.

3. Hold/Chirp/Release - After entering the PIN code, press and hold  until a chirp is heard and the LED turns on, then release the button. You have now entered the feature selection position of the User Selectable Features grid.
4. Column select - Press  the same number of times as the desired column. After a pause the siren will chirp the same number of times as the selected column for confirmation.
5. Feature select - Press  the same number of times as the desired feature. The siren will chirp with each press. The feature can now be changed using the remote control.
6. Feature change - Press the arm/disarm button on the transmitter. If the system chirps once, the feature has just turned off; if the system chirps twice, the feature has just turned on. If the feature has more than two settings, continue pressing the arm/disarm button on the transmitter to toggle through the settings.













To advance to the next feature in the same column, press  the same number of times as the desired feature within 60 seconds; to change a feature in a different column begin at step 4 by entering the column number first and then the row number.

NOTE: Refer to the Feature Descriptions sections of this guide for important notes and descriptions of the system features and programming.

7. Exit programming - To exit programming mode turn the ignition off or wait 60 seconds without pressing the PlainView 2 Valet switch. The siren will chirp three times to indicate programming mode has been exited.

user selectable features

*NOTE: Factory default settings are shown in **bold**.*

Then Press \ First Press	1 x 	2 x 	3 x 
1 x 	Add new remote (autolearn)	Set PIN code (default = 2)	New remote learn arm/disarm only
2 x 	Auto (passive) arm off/on	Select siren sounds	New remote learn accessory A channel
3 x 	Chirps off/on/quiet	FACT II off/on	New remote learn accessory B channel
4 x 	Auto lock off/ignition/rpm	Remote valet off/on	New remote learn silent mode
5 x 	Auto unlock off/ignition	Entry delay off/on	New remote learn remote valet
6 x 	Auto (passive) arm and lock off/on	Reset to default (except transmitter and valet code)	New remote learn remote start*
7 x 	Siren duration 30/60/90	Panic off/on	New remote learn window down/vent**
8 x 	Second unlock off/on	Autostart setting* (off/battery only/ temp only/ battery and temp)	New remote learn accessory C channel
9 x 	Not used	BlackJax off/on	Clear all remotes

* This feature is only available with optional IntelliStart connected.

** This feature is only available with optional SmartWindows connected.

user selectable features descriptions - column one

add new remote (only applicable with Radar 2 remote)

- Auto-learn new remote controls to the system in the standard button configuration. For more information, see programming note #1.

auto (passive) arm - off/on

- Off: The transmitter must be used to arm the system.
- On: When the system sees the ignition turn off and the last protected entry (door, hood, or trunk) close, it will begin a 30-second countdown before arming itself. After the first five seconds, you will hear two chirps and the lights will flash. The system will arm 25 seconds later.

chirps - off/on/quiet

- Off: Chirps will not sound when arming/disarming the system.
- On: Chirps will sound when arming/disarming the system.
- Quiet: Chirps will sound when arming/disarming the system but at a lower volume than normal.

auto lock - off/ignition/rpm

- Off: The doors will not lock automatically.
- Ignition: The doors will automatically lock three seconds after the ignition is turned on unless a door is open at that time.
- Rpm: The doors will lock when the system sees the engine reach a preprogrammed RPM. The H1/4 VIOLET/BLACK or Intellistart must be connected.

auto unlock - off/ignition

- Off: The doors will not automatically unlock when the ignition is turned off
- Ignition: The doors will automatically unlock as soon as the ignition is turned off.

auto (passive) arm lock - off/on

- Off: The doors will not lock when the system passively arms.
- On: The doors will lock when the system passively arms. This feature only applies when passive arming is programmed on.

siren duration - 30/60/90

- The system will sound the alarm for the programmed duration (30/60/90 seconds) during an alarm trigger or when the system is put into panic mode.

second unlock - off/on

- Off: Second unlock output is pulsed at the same time as the unlock output when the system is disarmed.
- On: Second unlock output is active when the arm/disarm button is pressed within 10 seconds of disarming the system.

user selectable features descriptions - column two

set pin code

- This feature allows the setting of the user's personal PIN code. For more information, see programming note #5. The factory default PIN code is 2.

select siren sounds

- The individual sounds the siren produces during an full trigger alarm can be customized for owner recognition of an alarm trigger. For more information, see programming note #3.

fact II off/on

- Off: The alarm will respond to zone inputs indefinitely without bypassing.
- On: The alarm will bypass for 60 minutes zones that are triggered three times within a one hour period.

remote valet off/on

- Off: The alarm can not be put into valet mode with the remote control.
- On: The alarm can be put into valet mode with the remote control.

entry delay off/on

- Off: There is no entry delay when the system has passively armed. The system will trigger instantly when a door is opened.
- On: If the system has passively armed, it will not trigger for 15 seconds after a door is opened allowing the user to enter the vehicle and disarm the system via the PlainView 2 Valet switch.

reset to default settings

- All system settings (except PIN and remote programming) in the User Programming grid will be reset to their default factory setting as indicated in bold lettering.
- Press the arm/disarm button of the TX; the siren will chirp twice as confirmation.

panic off/on

- Off: The panic feature is not available.
- On: The panic feature is available.

auto start setting - off/battery only/temp only/battery and temp

NOTE: This feature is only available with the IntelliStart option.

- Off: The vehicle will not autostart.
- Battery: The vehicle will only autostart when the car battery gets low.
- Temperature: The vehicle will only autostart at a preset low temperature.
- Battery and temperature: The vehicle will autostart with a low car battery or low temperature.

NOTE: Temperature and battery calibration and settings can be made only with the Cliffnet Wizard.

blackjax off/on/

- Off: The system cannot enter BlackJax mode.
- On: The system will enter BlackJax mode when triggered.

user selectable features descriptions - column three

The features in this column pertain to programming individual transmitter channels in custom configurations. Following is an explanation of the features. Program the individual transmitter channels following the instructions in programming note #2.

arm/disarm only

- The remote control channel programmed into this feature will arm/disarm the system only.

NOTE: When programming a new remote control to custom configuration a channel must first be programmed to this feature before programming the remaining channels.

accessory a output

- The transmitter channel programmed into this feature will activate the accessory output.

accessory b output

- The transmitter channel programmed into this feature will activate the accessory output.

silent mode

- The transmitter channel programmed into this feature will arm/disarm the system, but the siren will not chirp.

remote valet

- The transmitter channel programmed into this feature will make the system enter/exit valet mode.

remote start

- This feature is only available with IntelliStart connected.
- The transmitter channel programmed into this feature will activate or shut down the Intellistart remote start system.

window control

- This feature is only available with SmartWindows connected.
- The transmitter channel programmed into this feature will activate the vent or roll down feature of the SmartWindows system.

accessory c output

- The transmitter channel programmed into this feature will activate the accessory output.









clear all remotes

- This feature will erase all remote codes from the system memory. This feature is convenient for erasing any transmitters that have been lost, stolen, or incorrectly programmed into the system.
- After entering this feature press any button on the transmitter; the siren will chirp to indicate that all transmitters have been erased from memory.

installer selectable features

To enter the Installer Selectable Features grid follow the instructions for the User Selectable Features with the exception of step 4. Perform step 4 as described below to enter the Installer Selectable Features grid.

Hold/Chirp/Release - After entering the PIN code, press and hold  until the siren chirps once. Continue holding for approximately 10 seconds until the siren chirps three times, then release the button. You have now entered the feature selection position of the Installer Selectable Features grid.

Then Press \ First Press	1 x 	2 x 	3 x 
1 x 	Lock pulse single /double	Acc. output A P1 */P2**/timer A/latch/latch (ignition reset)	Program RPM
2 x 	Unlock pulse single /double	Acc. output B P1 */P2**/timer B/latch/latch (ignition reset)	Engine type petrol /diesel***
3 x 	Lock pulse duration 0.8 /3.5 sec	One time valet off /on	Program SmartWindows 4****
4 x 	Delay domelight off /on	Timer A duration for acc output A	Horn output pulsed /latched
5 x 	Acc. output C auto-activate off /arm/disarm/both	Timer B duration for acc output B	Auto immobilization off /on
6 x 	Acc. output C P1 */P2**/timer C/latch/latch (ignition reset)	Timer C duration for acc output C	Not used

* P1 = Pulsed channel output is disabled with the ignition on or the alarm is armed.

** P2 = Pulsed channel output works anytime.

*** Only with optional IntelliStart connected.

**** Only with optional SmartWindows connected.

installer selectable features descriptions - column one

lock pulse - single/double

- Single: One door lock pulse will be output when the system arms.
- Double: Two door lock pulses will be output when the system arms.

unlock pulse - single/double

- Single: One door unlock pulse will be output when the system disarms.
- Double: Two door unlock pulses will be output when the system disarms.

lock pulse duration - 0.8/3.5 sec

- 0.8 seconds: The door lock pulses will be 800 milliseconds in length.
- 3.5 seconds: The door lock pulses will be 3.5 seconds in length.

delay domelight - off/on

- Off: Smart auto testing will generate a warning to indicate the door is open.
- On: Smart auto testing will ignore the domelight until it goes off.

accessory output c auto activation - off/arm/disarm/both

NOTE: The accessory output will not auto-activate if programmed to latched setting.

- Off.
- Arm: The accessory output will auto-activate when the system is armed.
- Disarm: The accessory output will auto-activate when the system is disarmed.
- Both: The accessory output will auto-activate when the system is armed and disarmed.

accessory output c programming

The auxiliary accessory output wire (PINK/BLACK) can be programmed for several different types of outputs.

- P1 0.8 seconds: The pulsed output is disabled with the ignition on or the alarm armed.
- P2 0.8 seconds: The pulsed output will operate any time.
- Timed: The length of output duration set.
- Latched: The output on/off controlled by button(s) controlling accessory.
- Latched (ignition reset): The output on/off controlled by button(s) controlling accessory if on, will turn off when the ignition is turned on.

installer selectable features descriptions - column two

accessory output a programming

The auxiliary accessory output wire (RED/WHITE) can be programmed for several different types of outputs.

- P1 0.8 seconds: The pulsed output is disabled with the ignition on or the alarm armed.
- P2 0.8 seconds: The pulsed output will operate any time.
- Timed: The length of output duration set.
- Latched: The output on/off controlled by button(s) controlling accessory.
- Latched (ignition reset): The output on/off controlled by button(s) controlling accessory if on, will turn off when the ignition is turned on.

accessory output b programming

The auxiliary accessory output wire (WHITE/BLUE) can be programmed for several different types of outputs.

- P1 0.8 seconds: The pulsed output is disabled with the ignition on or the alarm armed.
- P2 0.8 seconds: The pulsed output will operate any time.
- Timed: The length of output duration set.
- Latched: The output on/off controlled by button(s) controlling accessory.
- Latched (ignition reset): The output on/off controlled by button(s) controlling accessory if on, will turn off when the ignition is turned on.

one time valet - off/on

- Off: Does not allow one time valet mode feature.
- On: Allows one time valet mode feature.

accessory output a timer duration

- Start Timer: Press the arm/disarm button; the siren will chirp to signal the start of the timer duration setting.
- Stop Timer: Press the arm/disarm button; the siren will chirp to signal the end of the timer duration setting, or for maximum time, do not press the arm/disarm button.

NOTE: The timer max setting is 255 seconds.

accessory output b timer duration

- Start Timer: Press the arm/disarm button; the siren will chirp to signal the start of the timer duration setting.
- Stop Timer: Press the arm/disarm button; the siren will chirp to signal the end of the timer duration setting, or for maximum time, do not press the arm/disarm button.

NOTE: The timer max setting is 255 seconds.

accessory output c timer duration

- Start Timer: Press the arm/disarm button; the siren will chirp to signal the start of the timer duration setting.
- Stop Timer: Press the arm/disarm button; the siren will chirp to signal the end of the timer duration setting, or for maximum time, do not press the arm/disarm button.

NOTE: The timer max setting is 255 seconds.

installer selectable features descriptions - column three

rpm programming

- Programs the tachometer input for the BlackJax and door locks. For more information, see programming note #4.

engine type petrol/diesel

- This feature applies only if IntelliStart 4 is installed.
- Petrol: The IntelliStart will crank the engine three seconds after the ignition is turned on or after input on the wait-to-start wires ceases.
- Diesel: The IntelliStart will crank the engine 20 seconds after it turns the ignition on and will ignore the wait-to-start input wires.

NOTE: RPM must be reprogrammed after changing this feature.

smart windows program

- This feature applies only if SmartWindows is installed.
- Enter this feature and then follow the programming instructions included with SmartWindows.

horn output - pulsed/latched

- Pulsed: H2/9 YELLOW/WHITE wire will generate a pulsing (-) output when the alarm is in full trigger. When arming and disarming the output does not operate.
- Latched: H2/9 YELLOW/WHITE wire will generate a constant (-) output when the alarm is in full trigger. When arming and disarming the output will pulse as per the standard chirp pulses.

auto immobilization - off/on

- Off: Turns the auto immobilization feature off.
- On: Turns the auto immobilization feature on.

programming notes

Note #1: Adding a new transmitter in auto-learn configuration

- Press the arm/disarm button of the Radar 2 remote control; the siren will chirp once.



Note #2: Adding a new transmitter in custom-configuration

- For the arm/disarm channel, transmit the channel of the new three, four, or five button transmitter that you want to control that feature; the siren will then chirp once.
- For the rest of the channels, press the desired button on the remote to do the specified feature.

NOTE: When programming a new transmitter to custom configuration, an arm/disarm channel must first be programmed before programming the remaining channels.

Note #3: Selecting siren sounds

After entering this feature, press the arm/disarm button. The siren will generate a five-second sample of each available siren sound. Perform the following steps to add or delete that specific sound.

- Add sound: Press  on the PlainView 2 Valet switch while playing the desired sound to add that sound.
- Delete sound: Press  on the PlainView 2 Valet switch while playing the desired sound to delete that sound.

Note #4: RPM programming

- Drive the vehicle to an open area and allow the engine to warm up until the engine RPM drops to normal idle speed.
- Place the engine in park or neutral and set the parking brake.

- Enter the feature and press the arm/disarm button.
- The lights will flash twice to confirm the engine RPM has been learned.











NOTE: If only one flash is seen, the engine RPM was not successfully learned. Test the tach wire connection and retry.

- Turn the ignition off and activate BlackJax or RPM door locks to test.

Note #5: PIN Programming

A PIN code can have one to four digits; each digit can be from 0-9.

NOTE: A PIN code cannot begin with a zero.

- Programming Procedure
 1. Enter the feature location in the user-selectable programming grid.
 2. Immediately press and release  of the PlainView 2 Valet switch.
 3. Select each digit by pressing  1-9 times, and then press  to enter the number into the system. To enter a zero, press  only.
- To program a PIN code of 1032:
 1. Press and release  once and  once. You will hear one chirp.
 3. Press and release  once. You will not hear a chirp after programming a zero.
 5. Press and release  three times, and then press  once. You will hear three chirps.
 6. Press and release  two times, and then press  once. You will hear two chirps.
 4. Wait for two siren chirps after a five second pause or five seconds after the last digit has been entered if using less than four digit code number.
 5. Turn off the ignition; the siren will chirp three times.
 6. The programming mode is now exited.

- PIN Code Confirmation Procedure

Begin this procedure within 15 seconds of finishing the programming sequence or the new code will not be set.

1. Turn on the ignition.
2. Enter the new PIN code.
3. Press and hold  for three seconds.
 - LED turns on: New PIN code is learned and programming is complete.
 - LED stays off: New PIN code is not learned and the system reverts to the old PIN code. Repeat the programming sequence.

Note #6: Accessory Channels

- All accessory channels can be programmed to different types of outputs including a pulsed output defeated when ignition is on or the system is armed, a pulsed output regardless of the ignition/armed state, a timed output, a latched output, or a latched output that resets with ignition on.
- Accessory channel C can be programmed to auto-activate with the arm command of the transmitter, the disarm command of the transmitter, or both. Auto-activate can also be turned off and activate as a normal addition accessory channel output.

fact II - false alarm control technology

FACT II will bypass an input zone for 60 minutes if the system sees the same zone triggered three times within one hour, the system will bypass that input for 60 minutes. If that zone does not attempt to trigger the system during the 60 minute bypass period, the system will begin to monitor the zone again at the end of the hour. If it does attempt to trigger while bypassed the 60 minute time period starts over. FACT II will also bypass warn away triggers for the 60 minute duration.



FACT II requires that you change the way you test the system once you have it installed. Resetting FACT II requires the 60 minute time period expiring without attempted triggers or the ignition to be turned on and off. This allows the system to be repeatedly triggered, disarmed and rearmed, and still allow FACT II to bypass a faulty zone.

NOTE: Remember to reset with the ignition when testing sensors.

smart power up II

The Smart Power Up II feature ensures that when the security system is powered back up after being disconnected, the system will resume the same state it was in before power was lost. For example, if power is disconnected during a full trigger sequence, the system will still be in the full trigger sequence when power is reconnected to the unit. If power is disconnected while the unit is disarmed, it will still be disarmed when power is restored.

remote control sensor disable

1. Arm the system.
2. Use the transmitter to bypass the sensor by pressing  twice and then  button.
3. The lights will flash four times. All warn away zones are now bypassed.
4. Transmit the sensor bypass channel again.
5. The lights will flash four times again. The sensor warn away and full trigger zones are now bypassed.
6. The sensor zones will reset when disarmed.

mux sensors

audio sensor

The 506T Audio Sensor is a low-current device that provides an added level of protection to an existing security system by detecting sounds that have the acoustic signature of breaking glass or metal-to-glass impacts. It consumes less than 1 mA of current.

adjusting the audio sensor

NOTE: Before testing, all the doors and windows must be shut. If a window is open, the acoustics of the vehicle interior change dramatically. The customer should be informed of this. Also remember that Clifford security systems cannot trigger until three seconds after they are armed.

A single tap of a key or a coin should not trigger the sensor, since it is designed to react to multiple, closely-grouped sounds. A sharp rap with a set of keys should trigger the sensor. If the sensitivity needs to be increased, turn the adjustment screw an eighth of a turn and retest. If the sensitivity needs to be decreased, turn the adjustment

screw counter-clockwise and retest.

auto-immobilization feature

Immobilizer circuits automatically activate after 30 seconds.

NOTE: H1/17 orange ground when armed will not activate during Auto-Immobilization.

auto-immobilization sequence

1. Turn ignition off or disarm alarm.
2. After 30 seconds the systems Immobilization circuits activate and engage the starter and ignition interrupt.
3. LED blinks at ½ normal speed.

Disarm the system when immobilized

Use one of the following methods to turn off auto-immobilization.

- Turn ignition on and press the arm/disarm button of the transmitter.
- Arm the alarm and then disarm the alarm.
- Turn the ignition on and enter the system valet/PIN code.

one-time valet feature

This feature allows the system to be put in valet mode only until the next time the ignition is turned off.

ON: Valet mode will be exited every time the ignition is turned on.

OFF: Valet mode will only be exited by using the valet switch or the remote control.

blackjax feature

blackjax activation sequence

When BlackJax is programmed ON, BlackJax sequence will begin every time the ignition is turned on and must be turned off by entering your PIN code. It will then activate again while driving when triggered as described below.

NOTE: Blackjax can be turned off by entering PIN code at any time. 1. Ignition on.

- System sees input on Zone 7 ignition input.
2. Door Open & Close.
 - System sees input on H1/8 or H1/9 Door trigger input.
3. Press and release brake pedal.
 - a. System sees (+) input on H2/11 BROWN/WHITE brake input/output wire.
 - b. System then begins monitoring input on H1/4 VIOLET/BLACK wire or Intellistart 4.
 - c. System sees RPM at or above 2 x programmed rate, BlackJax begins 20 second countdown.
4. After a 20 second countdown:
 - a. 5 siren chirps as reminder to enter PIN code.
 - b. Brake light relay pulses (+) 12v on H2/11 BROWN/WHITE to flash brake lights.
 - c. You then have 20 more seconds to enter PIN to turn off Blackjax.
5. If PIN code is NOT entered within 20 seconds:
 - System sounds siren and begins flashing parking lights.
 - Brake lights continue to flash.
 - The system will now immobilize as described in steps 6-7.
6. If system sees the RPM rate return to 1 ½ times programmed RPM rate or lower, the system will immobilize the vehicle as described in step 7.
7. Vehicle Immobilization:
 - immobilizer will engage the starter and ignition circuits.
 - The siren will continue to sound and the parking and brake lights will flash for a maximum of 5 minutes.
 - Immobilization circuits will remain active until correct PIN code is entered.

blackjax deactivation sequence

To deactivate BlackJax turn the key on and then enter the PIN code at any time.

bypass blackjax temporarily (if on in program grid)

Bypass BlackJax temporarily

1. Turn ignition on.
2. Enter PIN code. Do not enter valet or programming mode.
3. Within 10 seconds: Press lock/unlock button of remote control.
4. Siren chirps 1 time as confirmation of BlackJax bypassed.
5. Turn Ignition Off, siren chirps 3 times as confirmation of exiting programming.

NOTE: If ignition remains on after entering PIN code and no action for 10 seconds, unit will automatically exit programming mode without chirps.

To return to normal BlackJax Operation

1. Turn ignition on.
2. Enter Pin code.
3. Within 10 seconds: Press lock/unlock button of remote control.
4. Siren chirps 2 times as confirmation of BlackJax active.
5. Turn ignition off, siren chirps 3 times as confirmation of exiting programming.

NOTE: If ignition remains on after entering PIN code and no action for 10 seconds, unit will automatically exit programming mode without chirps.

remote adjustable omnisensor

The Omnisensor is designed for ease of adjustment by the user and to give the ultimate in impact detection without the possibility of false triggers that are common with less sophisticated sensor.









installing the omnisensor



The omnisensor can be located in either the passenger or engine compartment. It must be firmly mounted with the indicator arrow pointing UP to a vertical metal surface. For best results it must be secured sheet metal screws using ALL FOUR mounting points.

adjusting the omnisensor

While adjusting this sensor it is required that you strike the vehicle with the amount of force that is desired for the system to trigger.

CAUTION! DO NOT strike window glass or flat sheet metal panels that can dent easily. It is recommended that you only strike the metal pillars between the windows, they are structurally sound enough not to dent. ONLY strike the pillars using the heel of your hand, it is more than sufficient for the sensor to distinguish as a theft attempt.

1. Disarm system.
2. Transmit Channel 15 (Press  3 times then  1 time).
 - The LED will turn on and the siren will chirp 1 time.
 - Sensor test and adjustment mode is entered.
3. To test Primary (full trigger) zone.
 - Press  of the remote control.
 - Siren will chirp 2 times.
 - Hit vehicle.
 - Siren chirps 1 time if hit hard enough to activate sensor.
4. Adjust Primary zone
 - Press  of the remote control.
 - Siren chirps 2 times.
 - Sensor adjustment mode is entered.
 - Hit vehicle at the desired level of impact.
 - Sensor adjusts itself to the force of Hit.
 - Siren chirps 1 time as confirmation of adjustment.
 - Press  of the remote control to lock adjustment.
5. To enter Warn-away zone adjustment
 - Press .
 - Siren chirps 1 time.
 - Warn-away zone adjustment is entered.
6. To test Warn-away zone
 - Press .
 - Siren will chirp 2 times.
 - Hit vehicle.
 - Siren chirps 1 time if hit hard enough to activate sensor.
7. Adjust Warn-away zone
 - Press .
 - Siren chirps 2 times.
 - Sensor adjustment mode is entered.

- Hit vehicle at the desired level of impact.
 - Sensor adjusts itself to the force of Hit.
 - Siren chirps 1 time as confirmation of adjustment.
 - Press  to lock adjustment.
8. Press  to re-enter Primary zone adjustment
- Siren chirps 2 times.
 - Primary zone can now be re-adjusted as described in #4.
 - Or press  again to exit programming mode.
 - The siren will chirp 3 times when sensor adjustment mode has been exited.

NOTE: You must wait 15-seconds for the Omnisensor to become active after arming.

second unlock feature

ON: System will monitor disarm channel for 10 seconds after disarm, if disarm channel is again transmitted within 10 seconds, H2/12 Blue/white will generate the programmed unlock output.

OFF: H2/12 Blue/white wire will generate the programmed unlock pulse at the same time as first unlock.

troubleshooting

Sensors do not trigger the alarm.

- Has the FACT II system been triggered? To check this, turn the ignition key on and off to clear the FACT II from memory, and then retest the shock sensor. For a detailed description of FACT II, see the *FACT II: False Alarm Control Technology* section of this guide.

Closing the door triggers the system, but opening the door does not.

- Have you correctly identified the type of door switch system? This happens often when the wrong door input has been used.

The system will not passively arm until it is remotely armed and then disarmed.

- Are the door inputs connected? Is a BLUE wire connected to the door trigger wire in the vehicle? The GREEN H1/9 or the VIOLET H1/8 should be used instead.

The PlainView 2 Valet switch does not work.

- Is the quick disconnect plugged in correctly?
- Is it plugged into the correct socket?
- Check the System Features Learn Routine for the default PIN code.

- Has the PIN code been changed?

The status LED does not work.

- Make sure that it is plugged in. (See the *Plug-In Harnesses* section of this guide.)
Is the LED plugged into the correct socket?
- Is the quick disconnect plugged in correctly?

wiring reference guide

