

Arrow5
installation guide



***IMPORTANT!** Please note that this manual was intended for US consumers and therefore includes American phrases or words.*

Bitwriter™, Code Hopping™, DEI®, Directed®, Doubleguard®, ESP™, FailSafe®, Ghost Switch™, Learn Routine™, Nite-Lite®, Nuisance Prevention Circuitry®, NPC®, Revenger®, Silent Mode™, Soft Chirp®, Stinger®, Valet®, Vehicle Recovery System®, VRS®, and Warn Away® are all Trademarks or Registered Trademarks of Directed Electronics, Inc., Vista, California.

table of contents

what is included	.2
installation guide	.1
table of contents	.3
what is included	.4
transmitter configurations	.4
transmitter functions	.5
standard configuration	.5
primary harness wire connection guide	.6
primary harness wiring diagram	.6
primary harness wiring guide	.6
immobilizer harness wire connection guide	.11
immobilizer harness wiring diagram	.11
immobilizer harness wiring guide	.11
door lock harness wire connection guide	.12
type A: positive (+) 12-volt pulse	.12
type B: negative (-) pulse	.13
type C: reversing polarity	.14
type D: after-market actuators	.15
type E: mercedes-benz and audi (1985 & newer)	.16
type F: one-wire system	.17
type G: positive (+) multiplex	.18
type H: negative (-) multiplex	.19
peripheral plug-in harnesses	.20
super bright blue led, 2-pin white plug	.20
plain-view valet	.20
sensor harness, 4-pin connector	.21
mounting the receiver/antenna	.21
arming/disarming diagnostics	.22
arming	.22
disarming	.22
system status chirps	.23
multiple event total recall	.23
table of zones	.24
system features programming	.24
cliffnet wizard pro installation software programming	.24
manual programming instructions	.25
user selectable features	.26
user selectable features descriptions - column one	.26
user selectable features descriptions - column two	.28
user selectable features descriptions - column three	.29
installer selectable features	.30
installer selectable features descriptions	.31
programming notes	.33
fact II - false alarm control technology	.35
smart power up II	.35
remote control sensor disable	.36
troubleshooting	.36
wiring quick reference guide	.38

what is included

- One Arrow5 control module
- Two three-button transmitters
- One XHF antenna/receiver with harness
- One pre-wired blue status LE
- One PlainView 2 Valet switch
- One 514C Neo-Sire
- One 504C dual-stage shock sensor with harness
- One 18-pin main wiring harness
- One three-pin immobilizer harness
- One three-pin door lock harness
- One Owner's Guide
- Two window decals
- Warranty registration card
- Quick reference card
- Presentation envelope

transmitter configurations

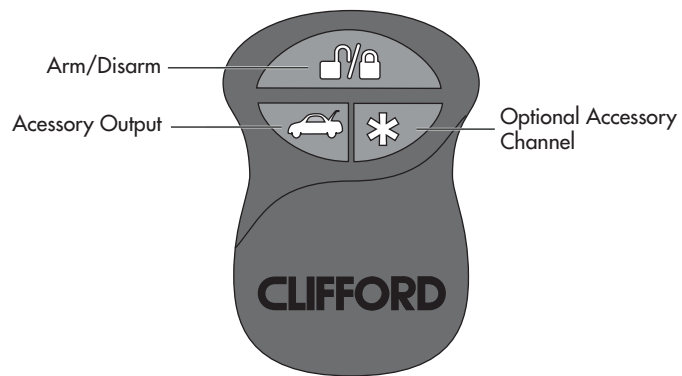

transmitter functions

This system uses computer-based code learning to learn the transmitter buttons. This makes it possible to assign any transmitter button to any system function. The transmitter initially comes programmed with standard configuration, but may also be customized by an authorized dealer. The buttons in all of the instructions in this manual correspond to a standard configuration transmitter.

standard configuration

 Button

The arming, disarming, and panic function are controlled by this button.

 Button

The trunk release or accessory output is controlled by this button.

 Button

An optional accessory convenience or expansion function that you have added to your system can be activated by pressing this button.

 and  Buttons

When pressed together, these buttons control silent arm and disarm.

 and  Buttons

When pressed together, these buttons disable the 504C shock sensor.

 and  Buttons

When pressed together, these buttons control the remote valet.

primary harness wire connection guide

primary harness wiring diagram

H1/1	BLACK	Ground
H1/2	EMPTY	Not Used
H1/3	EMPTY	Not Used
H1/4	EMPTY	Not Used
H1/5	EMPTY	Not Used
H1/6	EMPTY	Not Used
H1/7	BLUE	(-) Hood/Trunk Trigger Input - Zone 5
H1/8	VIOLET	(+) Door Trigger Input - Zone 4
H1/9	GREEN	(-) Door Trigger Input - Zone 4
H1/10	RED	(+) 12V Constant
H1/11	BROWN	(+) Siren Output
H1/12	WHITE/RED	Light Flash Input
H1/13	WHITE	Light Flash Output
H1/14	WHITE	Light Flash Output
H1/15	BLACK/WHITE	(-) Dome Light Supervision Output (200mA)
H1/16	RED/WHITE	Accessory Output A
H1/17	ORANGE	Ground When Armed
H1/18	YELLOW	Ignition Input

primary harness wiring guide

This guide describes in detail the connection of each wire. Also included are possible applications of each wire. This system was designed with the ultimate in flexibility and security in mind. Many of the wires have more than one possible function. Please read the instructions carefully to ensure a thorough understanding of this unit and how it operates.

h1/1 black ground

Connect the BLACK wire to a clean, paint-free sheet metal location (driver's kick panel) using a factory bolt that does NOT have any vehicle component grounds attached to

it. A screw should only be used in conjunction with a two-sided lock washer. Under dash brackets and door sheet metal are not acceptable ground points. It is recommended that all security components be grounded at the same location.

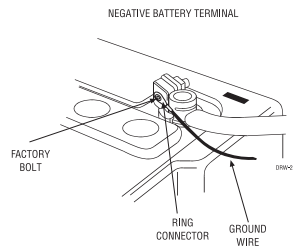
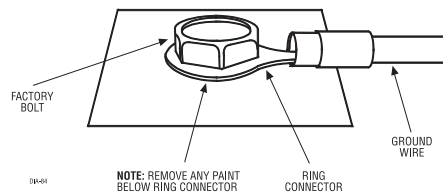

h1/7 blue (-) hood/trunk trigger input - zone 5

This input will respond to a negative input with an instant trigger. It is ideal for hood and trunk pins and will report on Zone 5. It can also be used with Directed single-stage sensors. The H1/7 BLUE instant trigger wire can also be used to shunt sensors during operation of auxiliary channels or remote start. (See the *Bypassing Sensor Inputs* section of this guide.)

h1/8 violet (+) door trigger input - zone 4

Connect the violet wire to a wire that shows (+)12V when any door is opened. This wire will report Zone 4.

h1/9 green (-) door trigger input - zone 4

Most vehicles use negative door trigger circuits. Connect the GREEN wire to a wire showing ground when any door is opened. When connecting to newer model vehicles there is generally a need to use individual door triggers. This wire will report Zone 4.

NOTE: If using a door trigger wire that has a delay, the installer-selectable programming grid or the Cliffnet Wizard can be used to turn the door ajar warning off.

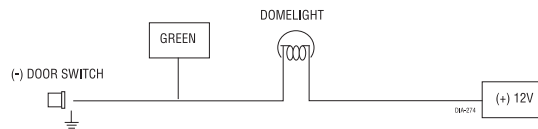

h1/10 red (+) 12v constant

Before connecting the RED wire, remove the supplied fuse. Connect to the battery positive terminal (be sure to use the supplied fuse holder and a 5 amp fuse) or the constant (+) 12V supply to the vehicle fusebox.

h1/11 brown (+) siren output

Connect the BROWN (+) siren output wire to the RED wire of the 514C. Connect the BLACK wire of the siren to (-) chassis ground at the same point you connect the control module's BLACK ground wire.

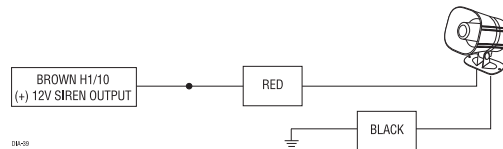

h1/12 white/red light flash input

This wire is the input for the on-board dual light flash relay. If the vehicle has positive parking light activation wires, connect this wire to a constant (+) 12V source that is fused at 15A or higher (be sure to use the supplied fuse holder and a 15 amp fuse). If the vehicle parking light activation wire is negative, connect this wire to a chassis ground location.

h1/13 and h1/14 white parking light output

These wires are the output of an on-board dual make relay and should be connected to wires in the vehicle that control the parking light wire polarity. The dual outputs are designed for European vehicles with isolated parking light systems. If the vehicle's parking lights are controlled by a single wire, connect both WHITE wires to it.

IMPORTANT! The polarity of this wire is determined by the connection of the H1/12 light flash input wire. Always confirm light flash polarity before connecting H1/12 or damage to the vehicle lighting system could occur.

h1/15 black/white (-) dome light supervision output (200mA)

Connect the H1/15 BLACK/WHITE wire to the optional domelight supervision relay as shown in the following diagram.

IMPORTANT! This output is only intended to drive a relay. It cannot be connected directly to the domelight circuit, as the output cannot support the current draw of one or more bulbs.

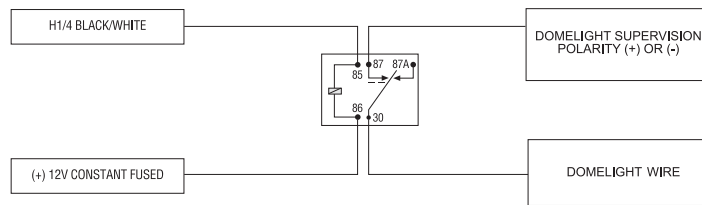

08-01

h1/16 red/white accessory output

When the system receives the code controlling the accessory output, this wire will supply an output as long as the transmission continues. This is often used to operate a trunk/hatch release or other relay-driven function.

IMPORTANT! Never use this wire to drive anything but a relay or a low-current input! The transistorized output can only supply 200 mA of current. Connecting directly to a solenoid, motor, or other high-current device will cause it to fail.

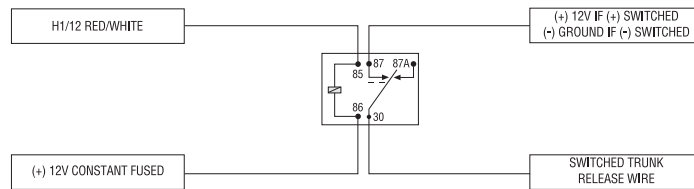

h1/17 orange ground when armed

This wire provides a (-) ground output as long as the system is armed and will cease when the system is disarmed. This output can be used for an additional immobilizer relay or to control additional accessories such as window automation, voice modules, or pagers.

h1/18 yellow ignition input

Connect this wire to the (+) 12V ignition wire that is (+) 12V in the ignition and crank positions. Take great care that this wire cannot be shorted to the chassis at any point.

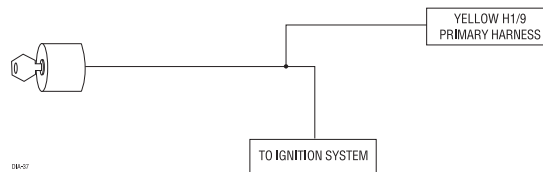

immobilizer harness wire connection guide

immobilizer harness wiring diagram

H2/1	BLACK	Starter - Common (Keyside)
H2/2	BLACK	Starter - Normally Closed (Motorside)
H2/3	BLACK	Starter - Normally Open (Motorside)

immobilizer harness wiring guide

h2/1, h2/2, and h2/3 black immobilizer pigtail harness

The starter immobilizer harness can be installed as a normally open or normally closed circuit by connecting the desired side of the three-wire immobilizer. Locate the starter wire, then cut it and make connections as described in the following diagram. Connect H2/1 to the end of the wire that is still connected to the ignition switch; connect H2/2 or H2/3 to the end of the wire that continues to the vehicle's starter circuit.

NOTE: Factory settings is normally closed if wired for normally open you must change the programming.

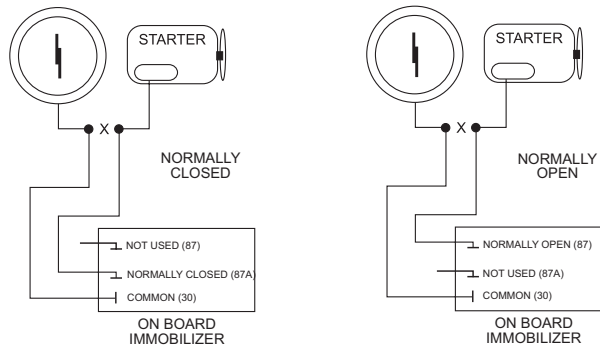

door lock harness wire connection guide

H3/1	GREEN	(-) Lock, (+) Unlock Output
H3/2	EMPTY	(+) 12V Protected, Low Current for 451M
H3/3	BLUE	(-) Unlock, (+) Lock Output

IMPORTANT! The door lock outputs are low current and should not be attached directly to any high-current device; they are only to be used to activate relays

type A: positive (+) 12-volt pulse

The system can control Type A door locks directly, with no additional parts. The switch will have three wires on it; one will test (+)12 volt constantly. The others will alternately pulse (+)12 volt when the switch is pressed to the lock or unlock position.

If you cannot get to the switch, and you find a set of wires that pulse (+)12 volt alternately on lock and unlock, make sure that it is not a Type C direct-wire system.

Here is a test:

Cut the wire that pulses (+)12 volt on lock, and then operate the switch to unlock.

- If all doors unlock, the vehicle uses type A system.
- If you lose all door lock operation in both directions, you are operating the master switch in a Type C system.
- If you lose all door lock operation of one or more, but not all motors, and other doors still work, you have cut a wire leading directly to one or more motors. You must instead find the actual wires leading to the switch.

IMPORTANT! Remember that these wires' functions reverse between Type A and Type B.

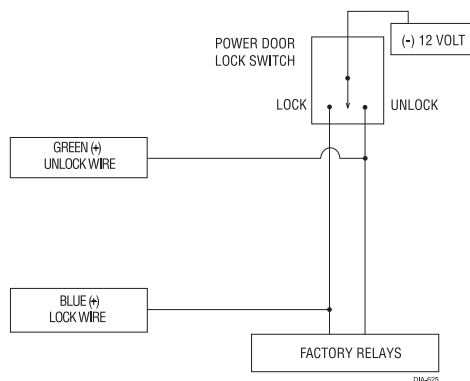

type B: negative (-) pulse

This system is common in many Toyotas, Nissans, Hondas, and Saturns, as well as Fords with keyless entry systems (some other Fords also use Type B). Most European Ford vehicles with (-) negative pulse locking are high current so a 451M or 2 relays need to be used.

The switch will have three wires on it, and one wire will test ground all the time. One wire will pulse negative (-) when the switch locks the doors, and the other wire will pulse negative (-) when the switch unlocks the doors. This type of system is difficult to mistake for any other type.

IMPORTANT! Remember that these wires' functions reverse between Type A and Type B.

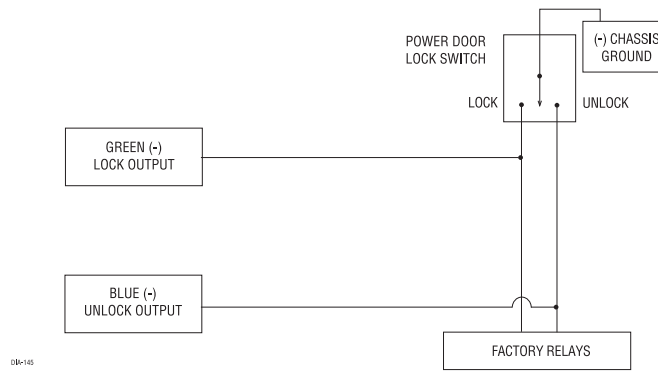

type C: reversing polarity

Interfacing with a reversing polarity system requires either two relays or one DEI 451M (not included). It is critical to identify the proper wires and locate the master switch to interface the door locks properly. Locate wires that show voltage on lock and unlock. Cut one of the suspected wires and check operation of the locks from both switches. If one switch loses operation in both directions and the other switch operates in one direction only, you have located one of the target wires. The switch that lost all operation is the master switch. If one switch works in both directions and the other switch works in only one direction, you have a Type A system. If both switches still operate, but one or more doors has stopped responding entirely, you have cut a motor lead. Reconnect it and continue to test for another wire. Once both wires have been located and the master switch has been identified, cut both wires and interface as shown in the following diagram.

IMPORTANT! If these wires are not connected properly, you will send (+) 12 volt directly to (-) ground, possibly damaging the alarm or the factory switch.

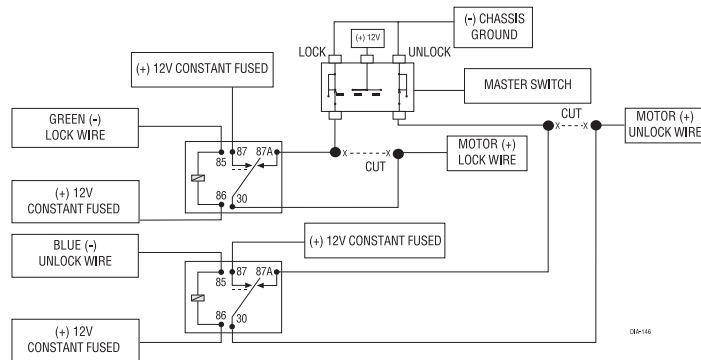

IMPORTANT! Do not connect the outputs of the alarm directly to the actuator.

type D: after-market actuators

In order for this system to control one or more after-market actuators, a DEI 451M or two relays (optional) are required. Vehicles without factory power door locks require the installation of one actuator per door. This requires mounting the door lock actuator inside the door. Other vehicles may only require one actuator installed in the driver's door if all door locks are operated when the driver's lock is used.

The fuse used on 12 volt inputs should be 7.5A per motor installed in the vehicle.

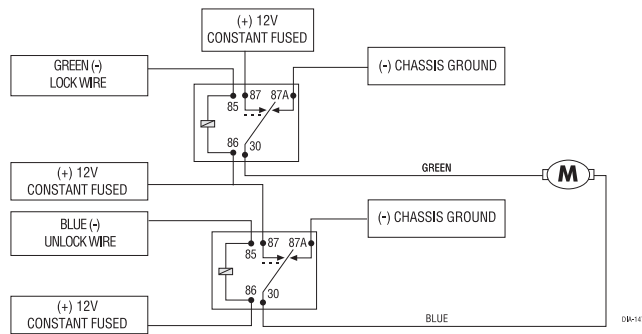

type E: mercedes-benz and audi (1985 & newer)

Type E door locks are controlled by an electrically activated vacuum pump. Some Mercedes and Audis use a Type D system. Test by locking doors from the passenger key cylinder. If all the doors lock, the vehicle's door lock system can be controlled with just two relays (optional). The control wire can be found in either kick panel and will show (+)12 volt when doors are unlocked and (-) ground when doors are locked.

To interface see diagram below. The system must be programmed for 3.5 second door lock pulses up to 1993 and 1 second pulse 1994 or newer.

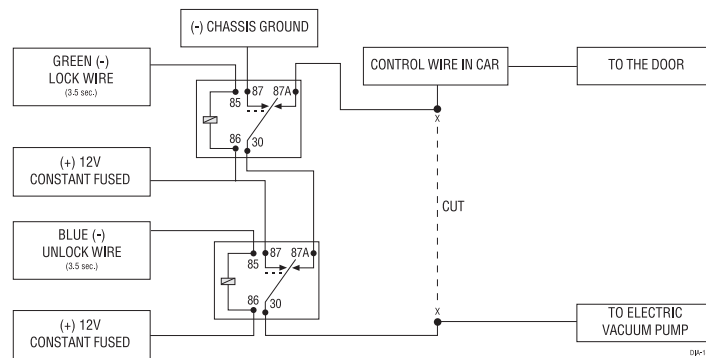

type F: one-wire system

Type F door locks usually require a negative pulse to unlock and cutting the wire to lock the door. In some vehicles, these functions are reversed. Type F door locks are found in late-model Nissan Sentras, some Nissan 240SX, and Nissan 300ZX 1992-up. They are also found in some Mazda MPVs, some Mitsubishi's, and Lotus.

One relay (optional) is used to interface to this type of system as follows:

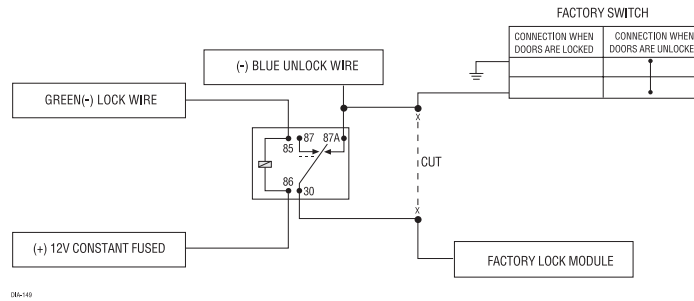

type G: positive (+) multiplex

The door lock switch or door key cylinder may contain either one or two resistors. When interfacing with this type of door lock system, two relays or a DEI 451M must be used.

Single-Resistor Type

If one resistor is used in the door lock switch/key cylinder, the wire will pulse (+)12 volt in one direction and less than (+)12 volt when operated in the opposite direction.

Two-Resistor Type

If two resistors are used in the factory door lock switch/key cylinder, the switch/key cylinder will read less than (+)12 volt in both directions.

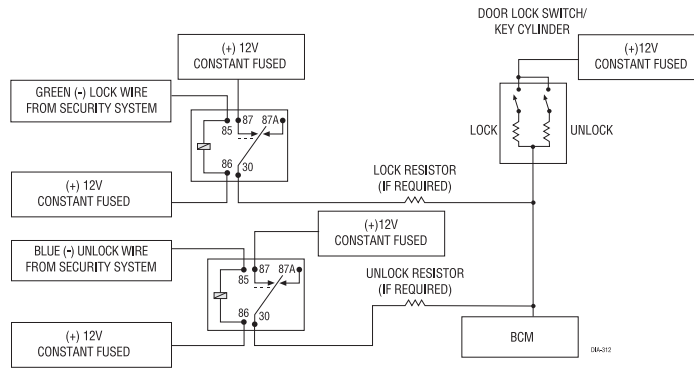

type H: negative (-) multiplex

The door lock switch or door key cylinder may contain either one or two resistors. When interfacing with this type of door lock system, two relays or a DEI 451M must be used.

Single-Resistor Type

If one resistor is used in the door lock switch/key cylinder, the wire will pulse ground in one direction and resistance to ground when operated in the opposite direction.

Two-Resistor Type

If two resistors are used in the factory door lock switch/key cylinder, the door lock switch/key cylinder will read resistance to ground in both directions.

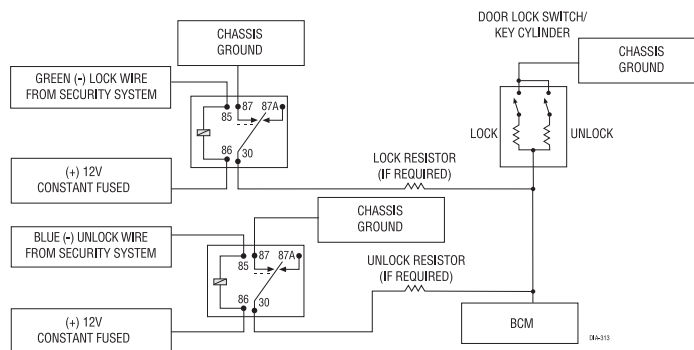

peripheral plug-in harnesses

super bright blue led, 2-pin white plug

The super bright LED operates at (+) 2V DC. Make sure the LED wires are not shorted to ground as the LED will be damaged. Multiple LEDs can be used, but they must be wired in series. The LED can be top-mounted or flush-mounted. If top-loading the LED with a bezel, the LED fits into a 5/16-inch mounting hole. If flush-mounting the LED from the back of a panel, drill a mounting hole using a 17/64-inch drill bit. Be sure to check for clearance prior to drilling the mounting hole.

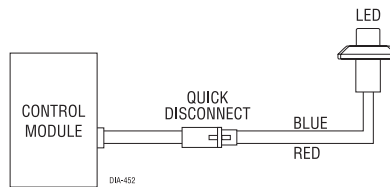

plain-view valet

The Valet/Program switch should be accessible from the driver's seat. It plugs into the blue port on the side of the unit. The switch is coded for protection so it need not be hidden. Consider how the switch will be used before choosing a mounting location. Check for rear clearance before drilling a 9/32-inch hole and mounting the switch.

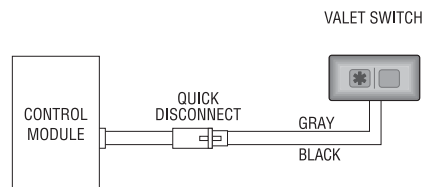

sensor harness, 4-pin connector

red and black wires

These wires supply constant 12 volts and ground to the sensor.

blue and orange wires, zone 3 zone 8

These wires are multiplex inputs. If a (-) input of less than 0.8 seconds is supplied to either wire, the Warn Away® response will occur. A (-) input of longer than 0.8 seconds to either wire will initiate the triggered sequence and report Zone 3 or Zone 8.

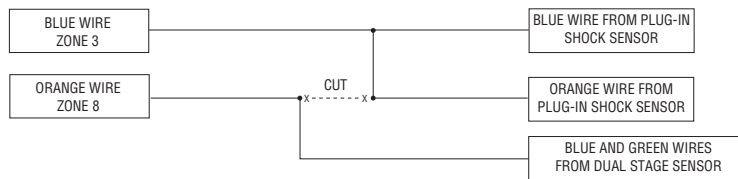

mounting the receiver/antenna

NOTE: Be sure not to bundle excess cable as this will reduce the range.

The receiver/antenna position should be discussed with the vehicle owner prior to installation since the antenna may be visible to the vehicle's operator.

The best position to locate the receiver/antenna is centered high on either the front or rear windshield. For optimal range, the antenna should be mounted vertically. It can be mounted horizontally in relation to the windshield or under the dashboard away from metal, but range will be reduced. Metallic window tint can also affect range, so this should be a consideration when determining the mounting location.

After determining the best mounting location, follow these steps:

1. Clean the mounting area with a quality glass cleaner or alcohol to remove any dirt or residue.
2. Plug the receiver/antenna cable into the receiver/antenna.
3. Mount the receiver/antenna with double-sided tape.
4. Route the receiver/antenna cable down the window pillar to the control module and plug the cable into the control module.

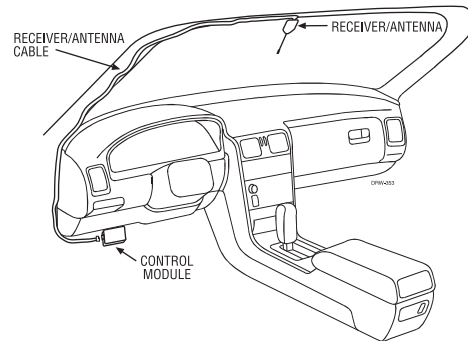

arming/disarming diagnostics

The systems microprocessor monitors and reports all active and violated zones when arming and disarming the system.

arming

Zones that are triggered at the time the system is armed are reported by an additional set of status chirps called *Malfunction AutoBypass*. The specific zone bypassed is then reported by the LED. For more zone information, refer to *Table of Zones* section of this guide.

disarming

If a zone is triggered, three disarm chirps will sound. The specific zone that was triggered is then reported by the LED when the ignition is turned on. For more zone information, refer to the *Table of Zones* section of this guide.

system status chirps

Action	No. of Chirps	Description
Arm	2	System armed.
Arm	4	System armed with hood and trunk bypass zones 5 and 6.
Arm	2 (5-second pause) 4	System armed with door bypass zones
Arm	2 (10-second pause) 4	System armed with sensor active and bypassed zones 3 and 8.
Disarm	1	System disarmed.
Disarm	3	System disarmed with zone violation
Disarm	5	System disarmed transmitter low battery

multiple event total recall

This will report the last eight system triggers.



1. Press and hold  of the PlainView 2 Valet switch.
2. While still holding , arm and disarm the system, then release the button.
3. The LED will start to blink to indicate the most recent trigger and proceed down to the eighth trigger. If fewer than eight triggers are stored in memory, the LED will blink continuously until the system is armed/disarmed using the transmitter after recalling the final trigger. For more information, please refer to the Table of Zones section of this guide.

table of zones

When using the diagnostic functions, use the Table of Zones to see which input has triggered the system. It is also helpful in deciding which input to use when connecting optional sensors and switches.

NOTE: The Warning Zone response does not report on the LED.

LED Flashes	Trigger type	Input description
3	Mux	Sensor input (Blue wire)
4	Instant	Door Pin
5	Instant	Hood/Trunk Pin
6	Instant	Hood (only with IS4)
7	Instant	Ignition
8	Mux	Sensor 2 Input (Orange wire)
10	N/A	Alarm power reset

system features programming

This system has many features that can be programmed to accommodate the user's personal preferences and make system installation easier. They are listed in two programming grids on the following pages. Many features have default setting that have been programmed at the factory and are indicated in bold type.

The User Selectable Features grid allows the user and installer to change operational features through the PlainView 2 Valet. The Installer Selectable Features grid allows the installer to change input/output functions of the system to integrate with the vehicle's specific characteristics.



cliffnet wizard pro installation software programming

Cliffnet Wizard Pro provides access to all available system features and some that are not available when manually programming with the Valet switch. Cliffnet Wizard Pro is compatible with Microsoft Windows 95/98/2000/ME/XP/NT so most programming operations can be accomplished by pointing and clicking with a mouse. This eliminates the need for programming grids and lengthy programming sequences. For a complete guide to system programming using the Cliffnet Wizard Pro refer to the Cliffnet Wizard help menu.



manual programming instructions

Be sure to document changes by taking note of all feature changes made in programming mode.

To enter the User Selectable Features programming:

1. Ignition on - Turn the ignition to the run position or start the engine.
2. Enter PIN - Enter the factory preset PIN code of 2 by pressing  on the PlainView 2 Valet switch twice, then  once.

NOTE: If the factory preset PIN has been changed, the new PIN must be entered.











3. Hold/Chirp/Release - After entering the PIN code, press and hold  until a chirp is heard and the LED turns on, then release the button. You have now entered the feature selection position of the User Selectable Features grid.
4. Column select - Press  the same number of times as the desired column. After a pause the siren will chirp the same number of times as the selected column for confirmation.
5. Feature select - Press  the same number of times as the desired feature. The siren will chirp with each press. The feature can now be changed using the remote control.
6. Feature change - Press the arm/disarm button on the transmitter. If the system chirps once, the feature has just turned off; if the system chirps twice, the feature has just turned on. If the feature has more than two settings, continue pressing the arm/disarm button on the transmitter to toggle through the settings.

To advance to the next feature in the same column, press  the same number of times as the desired feature within 60 seconds; to change a feature in a different column begin at step 4 by entering the column number first and then the row number.

NOTE: Refer to the Feature Descriptions sections of this guide for important notes and descriptions of the system features and programming.

7. Exit programming - To exit programming mode turn the ignition off or wait 60 seconds without pressing the PlainView 2 Valet switch. The siren will chirp three times to indicate programming mode has been exited.

user selectable features

Then Press \ First Press	1 x 	2 x 	3 x 
1 x 	Add new remote (autolearn)	Set PIN code	New remote learn arm/disarm only
2 x 	Auto arm on/off	Select siren sounds*	New remote learn accessory output
3 x 	Chirps on/off/quiet*	FACT II on/off	New remote learn silent mode
4 x 	Auto lock ignition/off/rpm**	Remote valet on/off	New remote learn remote valet
5 x 	Auto unlock ignition/off	Entry delay on/off	New remote learn remote start**
6 x 	Passive lock on/off	Reset to default (except transmitter and valet code)	New remote learn window down/vent***
7 x 	Siren duration 30/60/90	Panic on/off	Clear all remotes
8 x 	Autostart/off** (battery only, temp only, and battery and temp)	Not used	Not used

* This feature is only available with optional 515C siren.

** This feature is only available with optional IntelliStart connected.

*** This feature is only available with optional SmartWindows connected.

user selectable features descriptions - column one

add new remote (auto learn)

- Auto-learn new three-button cello remote controls to the system in the standard button configuration. For more information, see programming note #1.

auto arm - on/off

- On: When the system sees the ignition turn off and the last protected entry (door, hood, or trunk) close, it will begin a 30-second countdown before arming itself. After the first five seconds, you will hear two chirps and the lights will flash. The system will arm 25 seconds later.
- Off: The transmitter must be used to arm the system.

chirps - on/off/quiet

- On: Chirps will sound when arming/disarming the system.
- Off: Chirps will not sound when arming/disarming the system.

- Quiet: Chirps will sound when arming/disarming the system but at a lower volume than normal. This feature is only available with the 515C siren.

auto lock - **ignition**/off/rpm

- Ignition: The doors will automatically lock three seconds after the ignition is turned on unless a door is open at that time.
- Off: The doors will not lock automatically.
- Rpm: The doors will lock when the system sees the engine reach a preprogrammed RPM. This feature is only available with IntelliStart.

auto unlock - ignition/**off**

- Ignition: The doors will automatically unlock as soon as the ignition is turned off.
- Off: The doors will not automatically unlock when the ignition is turned off

passive lock - on/**off**

- On: The doors will lock when the system passively arms. This feature only applies when passive arming is programmed on.
- Off: The doors will not lock when the system passively arms.

siren duration - **30**/60/90

- The system will sound the alarm for the programmed duration (30/60/90 seconds) during an alarm trigger or when the system is put into panic mode.

auto start setting - **off**/battery only/temp only/battery and temp

- This feature is only available with the IntelliStart option.
- Off: The vehicle will not autostart.
- Battery: The vehicle will only autostart when the car battery gets low.
- Temperature: The vehicle will only autostart at a preset low temperature.
- Battery and temperature: The vehicle will autostart with a low car battery or low temperature.

NOTE: Temperature and battery calibration and settings can be made only with the Cliffnet Wizard Pro.

user selectable features descriptions - column two

set pin code

- This feature allows the setting of the user's personal PIN code. For more information, see programming note #5.

select siren sounds

- The individual sounds the 515C siren produces during an full trigger alarm can be customized for owner recognition of an alarm trigger. For more information, see programming note #3.

fact2 on/off

- On: The alarm will bypass for 60 minutes if zones 3, 5, and 8 are triggered three times within a one hour period.
- Off: The alarm will respond to zones 3, 5, and 8 inputs indefinitely without bypassing.

remote valet on/off

- On: The alarm can be put into valet mode with the remote control.
- Off: The alarm can not be put into valet mode with the remote control.

entry delay on/off

- On: If the system has passively armed, it will not trigger for 15 seconds after a door is opened allowing the user to enter the vehicle and disarm the system via the PlainView 2 Valet switch.
- Off: There is no entry delay when armed. The system will trigger instantly when a door is opened.

reset to default settings

- All system settings (except PIN and remote programming) in the User Programming grid will be reset to their default factory setting as indicated in bold lettering.
- Press the arm/disarm button of the TX; the siren will chirp twice as confirmation.

panic on/off

- On: The panic feature is available.
- Off: The panic feature is not available.

user selectable features descriptions - column three

The features in this column pertain to programming individual transmitter channels in custom configurations. Following is an explanation of the features. Program the individual transmitter channels following the instructions in programming note #2.

arm/disarm only

- The remote control channel programmed into this feature will arm/disarm the system only.

NOTE: When programming a new remote control to custom configuration a channel must first be programmed to this feature before programming the remaining channels.

accessory output

- The transmitter channel programmed into this feature will activate the accessory output.

silent mode

- The transmitter channel programmed into this feature will arm/disarm the system, but the siren will not chirp.

remote valet

- The transmitter channel programmed into this feature will make the system enter/exit valet mode.

remote start

- This feature is only available with IntelliStart connected
- The transmitter channel programmed into this feature will activate or shut down the Intellistart remote start system.

window control

- This feature is only available with SmartWindows connected
- The transmitter channel programmed into this feature will activate the vent or roll down feature of the SmartWindows system.







clear all remotes

- This feature will erase all remote codes from the system memory. This feature is convenient for erasing any transmitters that have been lost, stolen, or incorrectly programmed into the system.
- After entering this feature press any button on the transmitter; the siren will chirp to indicate that all transmitters have been erased from memory.

installer selectable features

To enter the Installer Selectable Features grid follow the instructions for the User Selectable Features with the exception of step 4. Perform step 4 as described below to enter the Installer Selectable Features grid.

Hold/Chirp/Release - After entering the PIN code, press and hold  until the siren chirps once. Continue holding for approximately 10 seconds until the siren chirps three times, then release the button. You have now entered the feature selection position of the Installer Selectable Features grid.

Then Press \ First Press	1 x 	2 x 	3 x 
1 x 	Lock pulse single/double	Acc. ouput A P1*/P2**/timed/latch/latch (ignition reset)	Starter Kill no/nc
2 x 	Unlock pulse single/double	Acc. output auto active off/arm/disarm/both	Program RPM***
3 x 	Lock pulse duration 0.8/3.5 sec	Acc. output timer duration	Engine type gas/diesel****
4 x 	Domelight delay on/off	Not used	Program SmartWindows****

- * P1 = Pulsed channel output is disabled with the ignition on or the alarm is armed.
- ** P2 = Pulsed channel output works anytime.
- *** Only with optional IntelliStart connected.
- **** Only with optional SmartWindows connected.

installer selectable features descriptions

lock pulse single/double

- Single: One door lock pulse will be output when the system arms.
- Double: Two door lock pulses will be output when the system arms.

unlock pulse single/double

- Single: One door unlock pulse will be output when the system arms.
- Double: Two door unlock pulses will be output when the system arms.

lock pulse duration 0.8/3.5 sec

- 0.8 seconds: The door lock pulses will be 800 milliseconds in length.
- 3.5 seconds: The door lock pulses will be 3.5 seconds in length.

domelight delay

- On: No malfunction autobypass chirps will be generated if any door triggers or the delay domelight are active when the system is armed.
- Off: Malfunction autobypass chirps will be generated if any door triggers or the delay domelight are active when the system is armed.

accessory output programming

The auxiliary accessory output wire (RED/WHITE) can be programmed for several different types of outputs.

- P1 0.8 seconds: The pulsed output is disabled with the ignition on or the alarm armed.
- P2 0.8 seconds: The pulsed output will operate any time.
- Timed: The length of output duration set.
- Latched: The output on/off controlled by button(s) controlling accessory.
- Latched (ignition reset): The output on/off controlled by button(s) controlling accessory if on, will turn off when the ignition is turned on.

accessory output auto activation type

NOTE: The accessory output will not auto-activate if the accessory output is programmed to either latched setting.

- Off.
- Arm: The accessory output will auto-activate when the system is armed.

- Disarm: The accessory output will auto-activate when the system is disarmed.
- Both: The accessory output will auto-activate when the system is armed and disarmed.

accessory output timer duration

- Start Timer: Press the arm/disarm button; the siren will chirp to signal the start of the timer duration setting.
- Stop Timer: Press the arm/disarm button; the siren will chirp to signal the end of the timer duration setting, or for maximum time, do not press the arm/disarm button.

interrupt no/nc

- NO: If the starter immobilizer circuit is normally open and power is lost to the system, the circuit will remain open and the starter will not operate.
- NC: If the starter immobilizer circuit is normally closed and power is lost to the system, the circuit will close and the starter will operate normally.

rpm programming

- This feature applies only if IntelliStart 4 is installed.
- Programs the tachometer input for the IntelliStart 4. For more information, see programming note #4.

engine type gas/diesel

- This feature applies only if IntelliStart 4 is installed.
- Petrol: The IntelliStart will crank the engine three seconds after the ignition is turned on or after input on the wait-to-start wires ceases.
- Diesel: The IntelliStart will crank the engine 20 seconds after it turns the ignition on and will ignore the wait-to-start input wires.

NOTE: RPM must be reprogrammed after changing this feature.

smart windows program

- This feature applies only if SmartWindows is installed.
- Enter this feature and then follow the programming instructions included with SmartWindows.

programming notes

Note #1: Adding a new transmitter in auto-learn configuration

- Press the arm/disarm button of the three-button cello remote control; the siren will chirp once.
- Immediately press arm/disarm again; the siren will chirp twice to confirm the new transmitter has been programmed.



Note #2: Adding a new transmitter in custom-configuration

- For the arm/disarm channel, transmit the channel of the new three, four, or five button transmitter that you want to control that feature; the siren will then chirp once.
- Immediately transmit the same channel again, the siren will chirp twice to confirm the transmitter channel has been programmed.
- For the rest of the channels, the siren will chirp the same number of times as the feature row.

NOTE: When programming a new transmitter to custom configuration, an arm/disarm channel must first be programmed before programming the remaining channels.

Note #3: Selecting siren sounds

After entering this feature, press the arm/disarm button. The siren will generate a five-second sample of each available siren sound. Perform the following steps to add or delete that specific sound.

- Personalized siren sounds require the use of a 515C in place of the standard siren.
- Add sound: Press  on the PlainView 2 Valet switch while playing the desired sound to add that sound.
- Delete sound: Press  on the PlainView 2 Valet switch while playing the desired sound to delete that sound.

Note #4: RPM programming

- Drive the vehicle to an open area and allow the engine to warm up until the engine RPM drops to normal idle speed.
- Place the engine in park or neutral and set the parking brake.
- Enter the feature and press the arm/disarm button.
- The lights will flash twice to confirm the engine RPM has been learned.











NOTE: If only one flash is seen, the engine RPM was not successfully learned. Test the tach wire connection and retry.

- Turn the ignition off and activate remote start to test.

Note #5: PIN Programming

A PIN code can have one to four digits; each digit can be from 0-9.

NOTE: A PIN code cannot begin with a zero.

- Programming Procedure
 1. Enter the feature location in the user-selectable programming grid.
 2. Immediately press and release  of the PlainView 2 Valet switch.
 3. Select each digit by pressing  1-9 times, and then press  to enter the number into the system. To enter a zero, press  only.
- To program a PIN code of 1032:
 1. Press and release  once and  once. You will hear one chirp.
 3. Press and release  once. You will not hear a chirp after programming a zero.
 5. Press and release  three times, and then press  once. You will hear three chirps.
 6. Press and release  two times, and then press  once. You will hear two chirps.
 4. Wait for two siren chirps after a five second pause or five seconds after the last digit has been entered if using less than four digit code number.
 5. Turn off the ignition; the siren will chirp three times.
 6. The programming mode is now exited.
- PIN Code Confirmation Procedure

Begin this procedure within 15 seconds of finishing the programming sequence or the new code will not be set.

1. Turn on the ignition.
2. Enter the new PIN code.
3. Press and hold  for three seconds.
 - LED turns on: New PIN code is learned and programming is complete.
 - LED stays off: New PIN code is not learned and the system reverts to the old PIN code. Repeat the programming sequence.

fact II - false alarm control technology

FACT II will bypass an input zone for 60 minutes if the system sees the same zone triggered three times within one hour, the system will bypass that input for 60 minutes. If that zone does not attempt to trigger the system during the 60 minute bypass period, the system will begin to monitor the zone again at the end of the hour. If it does attempt to trigger while bypassed the 60 minute time period starts over. FACT II will also bypass warn away triggers for the 60 minute duration.

FACT II requires that you change the way you test the system once you have it installed. Resetting FACT II requires the 60 minute time period expiring without attempted triggers or the ignition to be turned on and off. This allows the system to be repeatedly triggered, disarmed and rearmed, and still allow FACT II to bypass a faulty zone.

NOTE: Remember to reset with the ignition when testing sensors.

smart power up II

The Smart Power Up II feature ensures that when the security system is powered back up after being disconnected, the system will resume the same state it was in before power was lost. For example, if power is disconnected during a full trigger sequence, the system will still be in the full trigger sequence when power is reconnected to the unit. If power is disconnected while the unit is disarmed, it will still be disarmed when power is restored.

remote control sensor disable

1. Arm the system.
2. Use the transmitter to bypass the sensor.
3. The lights will flash four times. All warn away zones are now bypassed.
4. Transmit the sensor bypass channel again.
5. The lights will flash four times again. The sensor warn away and full trigger zones are now bypassed.
6. The sensor zones will reset when disarmed.

troubleshooting

Starter kill does not work.

- Is the correct starter wire being interrupted? If the car starts when the starter kill relay is completely disconnected, the wrong starter wire has been cut and interrupted.
- Is the YELLOW wire seeing true ignition? Is it connected to an accessory circuit?
- Has the no/nc feature been changed?

Shock sensor does not trigger the alarm.

- Has the FACT II system been triggered? To check this, turn the ignition key on and off to clear the FACT II from memory, and then retest the shock sensor. For a detailed description of FACT II, see the *FACT II: False Alarm Control Technology* section of this guide.

Closing the door triggers the system, but opening the door does not.

- Have you correctly identified the type of door switch system? This happens often when the wrong door input has been used.

The system will not passively arm until it is remotely armed and then disarmed.

- Are the door inputs connected? Is a BLUE wire connected to the door trigger wire in the vehicle? Either the GREEN H1/9 or the VIOLET H1/8 should be used instead.

The PlainView 2 Valet switch does not work.

- Is the quick disconnect plugged in correctly?
- Is it plugged into the correct socket?
- Check the System Features Learn Routine for the default PIN code.
- Has the PIN code been changed?

The status LED does not work.

- Make sure that it is plugged in. (See the *Plug-In Harnesses* section of this guide.)
Is the LED plugged into the correct socket?
- Is the quick disconnect plugged in correctly?

wiring quick reference guide

