

PYTHON®

700 Model

Installation Guide

NOTE: This product is intended for installation by a professional installer only! Any attempt to install this product by any person other than a trained professional may result in severe damage to a vehicle's electrical system and components.



© 2005 Directed Electronics, Inc. Vista, CA
N3201P 02-05



The Bitwriter® (p/n 998T)
requires chip version 1.4 or
newer to program this unit.

Bitwriter®, Code Hopping®, Doubleguard®, ESP™, FailSafe®, Ghost Switch™, Learn Routine™, Nite-Lite®, Nuisance Prevention® Circuitry, NPC®, Revenger®, Silent Mode™, Soft Chirp®, Stinger®, Valet®, Vehicle Recovery System®, VRS®, and Warn Away® are all Trademarks or Registered Trademarks of Directed Electronics, Inc.

www.directechs.com

DirectFax 800-999-1329 Technical Support 800-753-0800

These resources are for authorized Directed Dealer use only.

Table of Contents

Primary Harness (H1) Wire Connection Guide	5
Primary Harness Wiring Diagram.....	5
Primary Harness Wiring Instructions.....	5
Auxiliary Harness Wire Connection Guide	10
Auxiliary Harness Wiring Diagram.....	10
Auxiliary Harness Wiring Instructions.....	10
Door Lock Harness Wire Connection Guide	12
Relay Harness Wiring Diagram.....	12
Relay Harness Wiring Instructions.....	13
Immobilizer Wire Connection Guide	13
Immobilizer Wiring Diagram.....	13
Immobilizer Wiring Guide.....	13
Peripheral Plug-In Harnesses	14
Super Bright LED, 2-Pin WHITE Plug.....	14
Valet/Program Button, 2-Pin BLUE Plug.....	14
Programmer Interface, 3-Pin BLACK Plug.....	15
Mounting the Transceiver/Antenna.....	15
Optional Sensors, 4-Pin White Plug.....	16
Programming Jumper	16
Light Flash Jumper.....	17
Bypassing Sensor Inputs	17
System Features Learn Routine	18
System Features Menus	20
Menu #1 - Basic Features.....	20
Menu #2 - Advanced Features.....	21
Menu #3 - Advanced Features.....	22
Bitwriter Features.....	22
Feature Descriptions	23
Menu #1 - Basic Features.....	23
Menu #2 - Advanced Features.....	24
Transmitter/Receiver Learn Routine	29
Transmitter Configurations	31
Shock Sensor Adjustment	32
Enter Shock Sensor Adjustment Mode.....	32
Adjusting the Shock Sensor Setting.....	32
Reset Shock Sensor to Default Setting.....	33
Diagnostics	33
Arm/Disarm Diagnostics.....	33
System Status Chirps.....	34
Table of Zones.....	34
Long Term Event History	35

Multi-Level Security Arming.....	35
Optional Vehicle Recovery System (VRS®)	35
Nuisance Prevention® Circuitry	36
Rapid Resume Logic	36
Troubleshooting.....	36
Wiring Quick Reference Guide.....	39

Primary Harness (H1) Wire Connection Guide

Primary Harness Wiring Diagram

H1/1	RED/WHITE	(-) 200 mA Channel 2 Output
H1/2	RED	(+) Constant 12V Power Input (15A fused)
H1/3	BROWN	(+) Siren Output
H1/4	YELLOW	(+) Switched Ignition Input, Zone 5
H1/5	BLACK	(-) Chassis Ground Input
H1/6	VIOLET	(+) Door Trigger Input, Zone 3
H1/7	BLUE	(-) Instant Trigger Input (trunk input/shunt), Zone 1
H1/8	GREEN	(-) Door Trigger Input, Zone 3
H1/9	BLACK/WHITE	Domelight Supervision Relay Output #30
H1/10	WHITE/BLUE	(-) 200 mA Channel 3 Programmable Output
H1/11	WHITE	(+)/(-) Selectable Light Flash Output
H1/12	ORANGE	(-) 500 mA Ground-When-Armed Output

Primary Harness Wiring Instructions

This guide describes in detail the connection of each wire. Also included are possible applications of each wire. This system was designed with the ultimate in flexibility and security in mind. Many of the wires have more than one possible function. Please read carefully to ensure a thorough understanding of this unit.

H1/1 RED/WHITE 200 mA output channel 2 (trunk release)

This output is often used for trunk release. Whenever the button(s) controlling channel two is pressed for 1.5 seconds, this output is activated and will stay activated as long as the transmission continues. Use an external relay to drive circuits requiring more current.

H1/2 RED (+)12V constant power input

Before connecting this wire, remove the supplied fuse. Connect to the battery positive terminal or the constant 12V supply to the ignition switch.

NOTE: Always use a fuse within 12 inches of the point you obtain (+)12V. Do not use the 15 A fuse in the harness for this purpose. This fuse protects the module itself.

H1/3 BROWN (+) siren output

Connect this to the RED wire of the Revenger® siren. Connect the BLACK wire of the siren to (-) chassis ground, preferably at the same point you connect the control module's BLACK ground wire.

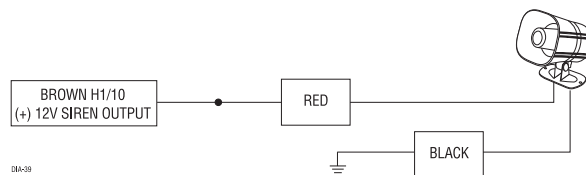

H1/4 YELLOW (+) ignition input

Connect this wire to the (+) 12 volts ignition wire. This wire must show (+) 12 volts with the key in RUN position and during cranking. Take great care to ensure that this wire is not shorted to the vehicle's chassis at any point.

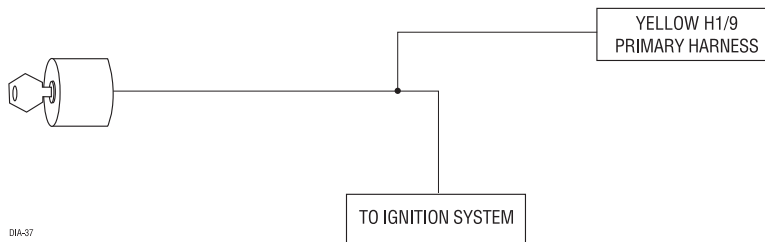

H1/5 BLACK (-) chassis ground connection

Connect this wire to a clean, paint-free sheet metal location (driver kick panel) using a factory bolt that DOES NOT have any vehicle component grounds attached to it. A screw should only be used when in conjunction with a two-sided lock washer. Under dash brackets and door sheet metal are not acceptable ground points. It is recommended that all security components be grounded at the same location.

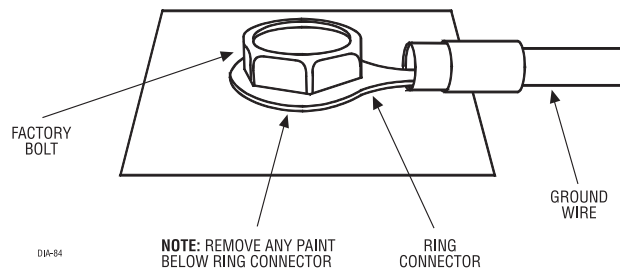

H1/6 VIOLET (+) door trigger input

This type of dome circuit is used in many Ford products. Connect the VIOLET wire to a wire that shows (+)12V when any door is opened. This wire will report Zone 3.

NOTE: If using a door trigger wire that has a delay, Advanced Menu 2, feature 6, or the 998T Bitwriter® can be used to turn Bypass Notification off.

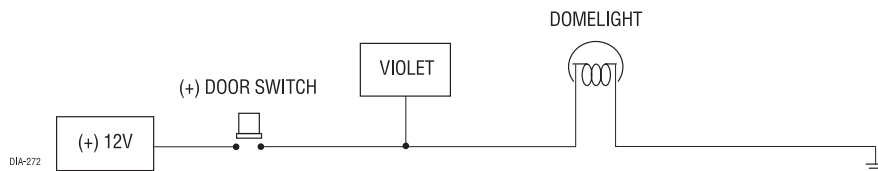

H1/7 BLUE (-) instant trigger input

This input will respond to a negative input with an instant trigger. It is ideal for hood and trunk pins and will report on Zone 1. It can also be used with Directed single-stage sensors. The H1/7 BLUE instant trigger wire can also be used to shunt sensors during operation of auxiliary channels or remote start. (See *Bypassing Sensor Inputs* section of this guide.)

H1/8 GREEN (-) door trigger input

Most vehicles use negative door trigger circuits. Connect the GREEN wire to a wire showing ground when any door is opened. When connecting to newer model vehicles there is generally a need to use individual door triggers. See DirectFax document 1076 for wiring instructions. This wire will report Zone 3.

NOTE: If using a door trigger wire that has a delay, Advanced Menu 2, feature 6, or the 998T Bitwriter® can be used to turn Bypass Notification off.

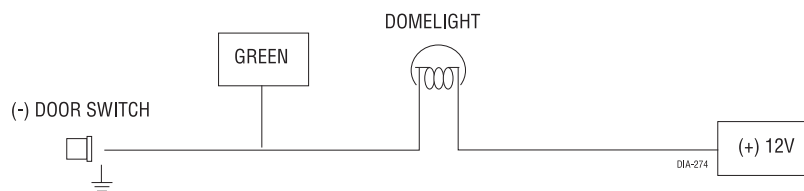

H1/9 BLACK/WHITE high current output from on-board domelight supervision relay

Connect this wire directly to the domelight circuit in the vehicle. The on-board relay will drive circuits up to 20 amperes. The polarity of this output is determined by the connection of the input wire H2/A in the Relay Harness.

NOTE: If the input wire H2/A is not connected, there will be no output on this wire.

H1/10 WHITE/BLUE 200 mA (-) channel 3 output

This wire provides a (-) 200 mA output whenever the transmitter button(s) controlling Channel 3 is pressed. This output can be programmed to provide the following types of output (see *System Features Learn Routine* section of this guide):

- A **validity** output will send a signal as long as the transmission is received.
- A **latched** output will send a signal continuously when the Channel 3 button(s) is pressed and released. The signal will continue until channel three is pressed again.
- A **latched/reset with ignition** output works similar to the latched output, but will also reset (output will stop) when the ignition is turned on and then off.
- A **30 (60, 90) second timed** output will send a signal for 30 seconds when channel three is pressed. This output can be shut off during the 30-second period by pressing Channel 3 again. The Bitwriter™ can program from 1 to 90 seconds.
- **Remote start** output (refer to System Features Menu description for additional information).

IMPORTANT! Never use this wire to drive anything but a relay or a low-current input! This transistorized output can only supply 200 mA, and connecting directly to a solenoid, motor, or other high-current device will cause the module to fail.

H1/11 WHITE (+/-) 10 A parking light flash output

The H1/11 WHITE wire is factory configured for (+) parking lights. Refer to the *Programming Jumper* section of this installation guide for changing configuration for (-) parking light.

NOTE: For parking light systems that draw 10 amps or more, the jumper must be switched to a (-) light flash output (see the *Programming Jumpers* section of this guide). P/N 8617 or a standard automotive SPDT relay must be used on the H1/11 light flash output wire.

IMPORTANT! DO NOT connect this wire to a negative vehicle light flash wire before changing the programming jumper to the negative polarity position or damage to vehicle light circuit may occur.

NOTE: A dual diode harness assembly is provided (Viper model only) for European vehicles which have parking light capability for illumination of only the parking lights on the side of the vehicle to the road when parked.

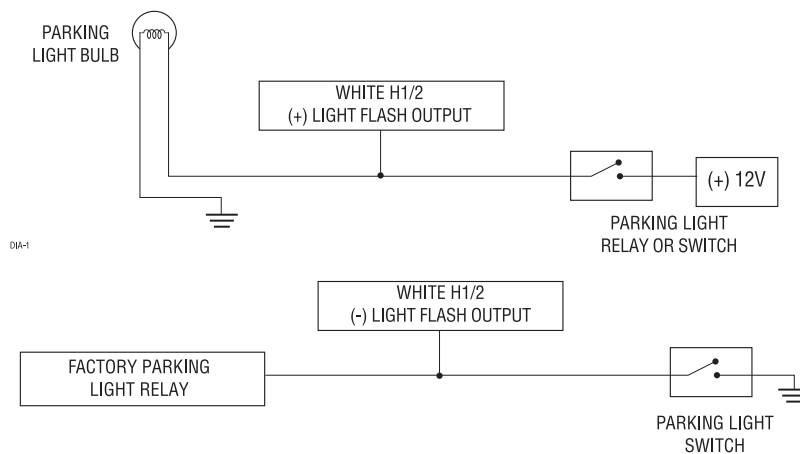

H1/12 ORANGE (-) ground-when-armed output

This wire supplies a (-) ground as long as the system is armed. This output ceases as soon as the system is disarmed. It can supply up to 500 mA of current.

Auxiliary Harness Wire Connection Guide

Auxiliary Harness Wiring Diagram

H2/1	LIGHT BLUE	(-) Second Unlock
H2/2	GREY	(-) Hood Pin Input, Zone 6
H2/3	ORANGE/BLACK	Retained Accessory Output
H2/4	GREY/BLACK	(-) Channel 6 Output
H2/5	WHITE/BLACK	(-) Channel 5 Output
H2/6	VIOLET/BLACK	(-) Channel 4 Output
H2/7	LIGHT BROWN	(-) Horn Honk Output
H2/8	LIGHT GREEN/BLACK	(-) Factory Disarm Output

Auxiliary Harness Wiring Instructions

H2/1 LIGHT BLUE (-) second unlock output (200mA)

This wire produces a (-) 200mA output for progressive locks in which the driver door unlocks first and the remaining locks unlock with a second press of the unlock button.

H2/2 GREY (-) hood pin input, zone 6 This wire is connected to hood pinswitch. This will trigger the security system if the hood is opened while the system is armed and report Zone 6. This input can be programmed for N.O. or N.C. contact, refer to *Systems Features Menus*.

H2/3 ORANGE/BLACK (-) retained accessory output

NOTE: An additional relay (not supplied) is required for most applications.

Connect this wire to the accessory wire in the vehicle that powers the accessories in the vehicle. This wire will retain power after the ignition key is turned off. This output ceases when a door is open/closed or the system is armed.

H2/4 GRAY/BLACK (-) channel 6 output

This wire provides a (-) 200mA output whenever the transmitter button(s) controlling Channel 6 is pressed. This output can be programmed to provide the following types of outputs (see also the Feature Menus section):

- **Validity:** Output that will send a signal as long as the transmission is received.
- **Latched:** Output that will send a signal when the Channel 6 button(s) is pressed and will continue until the same button(s) is pressed again.
- **Latched, reset with ignition:** Similar to the latched output, this type of output turns on the first time the Channel 6 button(s) is pressed and turns off the next time the same button is pressed. This type of output additionally stops and resets whenever the ignition is turned on and then off.
- **30-second (60, 90) timed:** Output that will send a continuous signal for 30 seconds. Bitwriter™ programs 1 to 90 seconds.

IMPORTANT! Never use this wire to drive anything but a relay or a low-current input! This transistorized output can only supply 200 mA, and connecting directly to a solenoid, motor, or other high-current device will cause the module to fail.

H2/5 WHITE/BLACK (-) channel 5 output

See H2/4 description.

IMPORTANT! Never use this wire to drive anything but a relay or a low-current input! This transistorized output can only supply 200 mA, and connecting directly to a solenoid, motor, or other high-current device will cause the module to fail.

H2/6 VIOLET/BLACK (-) channel 4 output

See H2/4 description.

IMPORTANT! Never use this wire to drive anything but a relay or a low-current input! This transistorized output can only supply 200 mA, and connecting directly to a solenoid, motor, or other high-current device will cause the module to fail.

H2/7 LIGHT BROWN (-) horn honk output (200mA)

This wire is a low current output (200mA) for the horn to sound. It can be programmed to sound only during full trigger or to be used like a siren output with arm/disarm chirps. Refer to *System Features Menu #3*, feature #2 in the manual for additional information.

H2/8 LIGHT GREEN/BLACK (-) factory disarm output

This wire sends a negative pulse every time the alarm is disarmed or the optional remote start is activated. This can be used to pulse the disarm wire of the vehicle's factory anti-theft device. Use a relay to send a (-) or (+) pulse to the disarm wire as shown in the diagrams below. This also outputs with CH2 is activated. This function is programmable ON/OFF.

Relay for Negative (-) Disarm Wire

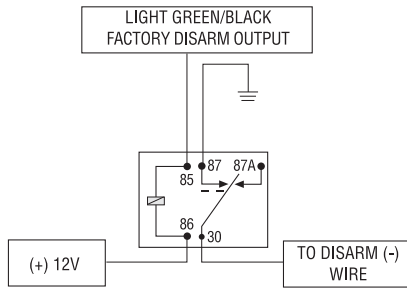

Relay for Positive (+) Disarm Wire

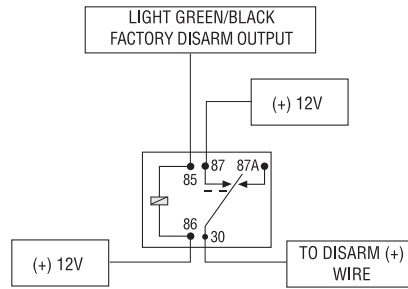

Door Lock Harness Wire Connection Guide

Relay Harness Wiring Diagram

H3/A	BLACK/WHITE	DomeLight Supervision relay Input #87
H3/B	WHITE/BLACK	Lock #87a Normally Closed
H3/C	GREEN/BLACK	Lock #30 Common (Output)
H3/D	VIOLET/BLACK*	Lock #87 Normally Open (Input)
H3/E	BROWN/BLACK	Unlock #87a Normally Closed
H3/F	BLUE/BLACK	Unlock #30 Common (Output)
H3/G	VIOLET*	Unlock #87 Normally Open (Input)

*NOTE: VIOLET and VIOLET/BLACK are common at fuse holder.

The system has door lock relays on-board, and can directly interface with most electric power door lock systems drawing 30 amps or less. It can also drive aftermarket actuators directly. (Some vehicles require that an aftermarket actuator be added to the driver's door to allow system control, see *Type D* wiring section in *Tech Tip Document 1041*). The lock wire also supplies the output for the comfort closure feature (if used).

Relay Harness Wiring Instructions

H3/A BLACK/WHITE input to on-board interior light illumination relay #87

This wire determines what the output polarity of H1/4 will be. If the door pin circuit is negative, connect to chassis ground. If the door circuit is positive, connect to a fused 12V source.

IMPORTANT! The H3/A wire is not required for wiring the door locks. Depending on the type of door lock system, there may be additional wires in the Door Lock Harness (H3) that are not required to be used in wiring the door locks.

H3/B – H3/G power door lock wires

The system has door lock relays on-board, and can directly interface with most electric power door lock systems drawing 30 amps or less.

Immobilizer Wire Connection Guide

Immobilizer Wiring Diagram

A	GREEN/BLACK	Starter - Normally Closed (motor side)
B	GREEN	Starter - Normally Open (motor side)
C	GREEN/WHITE	Starter - Common (key side)

Immobilizer Wiring Guide

The starter immobilizer harness can be installed as a normally open or normally closed circuit by connecting the desired side of the three-wire immobilizer. Locate the starter wire, then cut it and make connections as described in the following diagram. Connect wire C to the end of the wire that is still connected to the ignition switch; connect A or B wire to the end of the wire that continues to the vehicle's starter circuit.

Note: Factory default setting is normally closed, if wired for normally open you must change the programming.

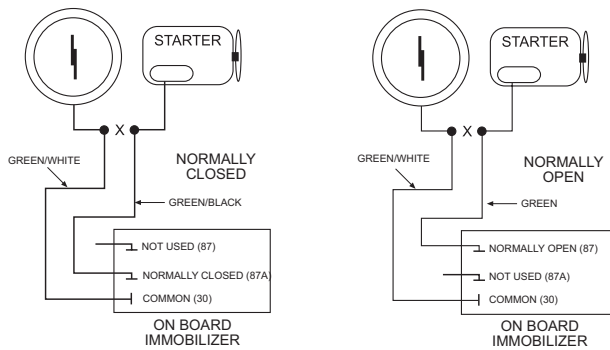

Peripheral Plug-In Harnesses

Super Bright LED, 2-Pin WHITE Plug

The super bright LED plugs into the two-pin WHITE port. Make sure the LED wires are not shorted to ground as the LED will be damaged. Two LEDs can be used, but they must be wired in series. The LED fits into a 9/32-inch mounting hole. Be sure to check for clearance prior to drilling the mounting hole.

NOTE: Never use a BLUE LED in combination with a RED LED.

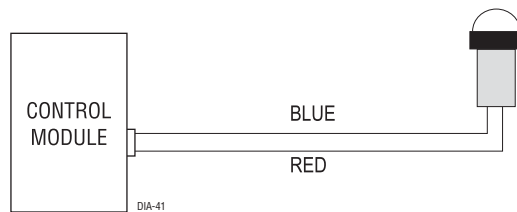

Valet/Program Button, 2-Pin BLUE Plug

The Valet/Program button should be accessible from the driver's seat. It plugs into the BLUE port on the side of the unit. Since the system features a Valet button, by using the remote transmitter, this button can be well hidden. Consider how the button will be used before choosing a mounting location. Check for rear clearance before drilling a 9/32-inch hole and mounting the button. The

GRAY wire in the two-pin plug may also be used as a (+) ghost switch input and can be connected to any (+) switch in the vehicle. (See *Feature Descriptions* section of this guide.)

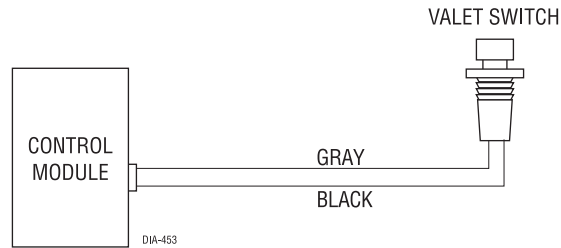

Programmer Interface, 3-Pin BLACK Plug



The BLACK three-pin port is provided for programming of the unit. When using the 998T Bitwriter®, it is possible to configure any and all of the programmable functions. For more information please refer to the guide packaged with the programmer.

Mounting the Transceiver/Antenna

Transceiver/antenna position should be discussed with the vehicle's owner prior to installation, since the antenna may be visible to the vehicle's operator.

The best location for the transceiver/antenna is centered high on either the front or rear windshield. For optimal range, the antenna should be mounted vertically. It can be mounted horizontally in relation to the windshield or under the dashboard away from metal, but range will be diminished. Metallic window tint can also affect range, so this should be a consideration when determining the mounting location.

After determining the best mounting location, follow these steps:

1. Clean the mounting area with a quality glass cleaner or alcohol to remove any dirt or residue.
2. Plug the transceiver/antenna cable into the transceiver/antenna.
3. Mount the transceiver/antenna using the supplied double-sided tape.
4. Route the transceiver/antenna cable to the control module and plug it into the four-pin antenna connector.

IMPORTANT! To achieve the best possible range, DO NOT leave the antenna cable bundled under the dash. Always extend the cable full length during installation, regardless of the antenna mounting location.

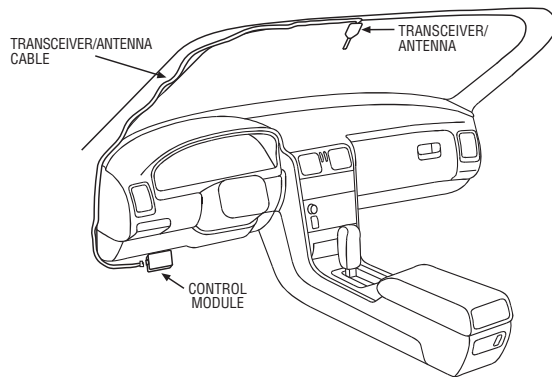

Optional Sensors, 4-Pin White Plug

There are two optional sensor input ports. Optional sensors which can be used are field, tilt, ultrasonic, or glass breakage. Alarm trigger inputs shorter than 0.8 seconds will trigger the Warn Away® response, while inputs longer than 0.8 seconds will trigger full alarm sequence and report Zone 4 or Zone 7 for multiplex input.

NOTE: The ground for the optional sensors is now controlled by the GWA.

Programming Jumper

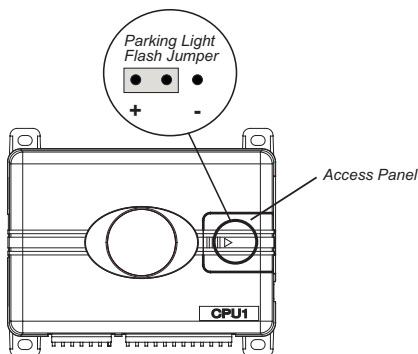

Light Flash Jumper

This jumper is used to determine the light flash output. In the (+) position, the on-board relay is enabled and the unit will output (+)12V on the WHITE wire, H1/11. In the (-) position, the WHITE wire, H1/11, will supply a 10 A (-) output suitable for driving factory negative parking light relays.

NOTE: For parking light circuits that draw 10 amps or more, the jumper must be switched to a (-) light flash output. P/N 8617 or a standard automotive SPDT relay must be used on the H1/11 light flash output harness wire.

IMPORTANT! DO NOT connect the H1/11 light flash wire to a negative vehicle light flash wire before changing the programming jumper to the negative polarity position or damage to vehicle light circuit may occur.

Bypassing Sensor Inputs

There are times when you need to temporarily bypass all sensor inputs to the unit, such as when activating the windows or remote starting the vehicle. Anytime an auxiliary channel output is used, sensor inputs are bypassed until 5-seconds after the output ceases. Anytime from the start of the output until the end of the bypass period, ground can be supplied to the H1/7 BLUE wire without triggering the unit. When the bypass period ends, if the unit sees ground on the H1/7 BLUE wire, zones 1, 2, 4, and 7 remain bypassed until five seconds after ground is removed from the BLUE wire. This can be done using the status output of a Directed Electronics remote engine starting unit as shown in the following diagram:

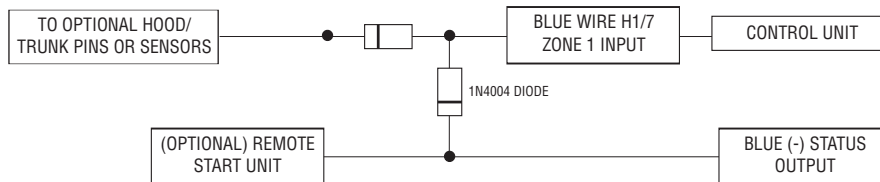

System Features Learn Routine

The System Features Learn Routine dictates how the unit operates. Due to the number of steps, they have been broken up into three menus. It is possible to access and change any of the feature settings using the Valet/Program button. However, this process can be greatly simplified by using the 998T Bitwriter®. Any of the settings can be changed and then assigned to a particular transmitter, up to four, a feature called Owner Recognition. Each time that particular transmitter is used to disarm the system, the assigned feature settings will be recalled. Owner Recognition is only possible when programming the unit via the 998T Bitwriter®.

If the system was previously programmed using the 998T Bitwriter®, the learn routine may be locked. If the siren generates one long chirp when attempting to program the unit, the learn routine is locked and must be unlocked using the 998T Bitwriter®.



1. **Open a door.** (The H1/8 GREEN wire or the H1/6 VIOLET wire must be connected.)



2. **Ignition.** Turn the ignition on, then back off: (The H1/4 YELLOW wire must be connected.)



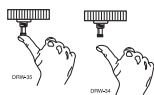

3. **Select a Menu.** Press and HOLD the Valet/Program button: (The Valet/Program button must be plugged into the blue port.) After three seconds the siren will chirp once indicating entry to the Basic Features Menu #1. If this is the menu you wish to access, release the button and go on to Step 4. If the button is not released, you will jump to the Advanced Features Menu #2 and the siren will chirp twice. If the button is still not released, you will jump to Advanced Features Menu #3 and the siren will chirp three times. Once you have selected the desired menu, release the Valet/Program button and then proceed to Step 4.



4. **Select a Feature.** Press and release the Valet/Program button the number of times corresponding to the feature you wish to change. For example, to access the second feature, press and release the button two times. Then press the button once more and HOLD it. The siren will chirp the number of times equal to the step you have accessed.



5. **Program the Feature.** While HOLDING the Valet/Program button, you can toggle the feature on and off using the remote transmitter. For the second feature, pressing  will select the chirps ON setting and the siren will chirp 1 time. Pressing  will change the programming to the chirps OFF setting and the siren will chirp twice. (See *System Features Menus* section of this guide.)

NOTE: For features with more than 2 settings pressing  will toggle through all the two-chirp settings and emit the corresponding number of chirps.



6. **Release the Valet/Program Button.**

Once a feature is programmed:

- Other features can be programmed within the same menu.
- Another menu can be selected.
- The learn routine can be exited if programming is complete.

To access another feature in the same menu:

1. Press and release the Valet/Program button the number of times necessary to advance from the feature you just programmed to the next one you want to program.
2. Then press the Valet/Program button once more and HOLD it.

For example, if you just programmed the third feature in the menu and you would like to program the seventh feature in the menu, you would press and release the Valet/Program button four times and then press it once more and HOLD it. The siren would chirp seven times to confirm access to the seventh feature.

To select another menu:

1. Press and HOLD the Valet/Program button.
2. After three seconds, the unit will advance to the next menu and the siren will chirp, indicating which menu has been accessed.

For instance, if you just programmed some features in Menu #1 (Basic Features) and you wish to program a feature in Menu #2, you press and HOLD the Valet/Program button. After 3-seconds, the siren chirps twice indicating access to Menu #2. To advance to Menu #3, continue to HOLD the Valet/Program button an additional 3-seconds until the siren chirps three times indicating access to Menu #3.

To exit the learn routine do one of the following:

- Close the open door.
- Turn the ignition on.
- No activity for longer than 15 seconds.
- Press the Valet/Program button too many times.

System Features Menus

Menu #1 - Basic Features

Items in bold text have been programmed to the default setting at the factory.

Feature Number	One Chirp Setting	Two-Chirp Setting
1-1	Active arming	Passive arming
1-2	Chirps ON	Chirps OFF
1-3	Ignition controlled door locks ON	Ignition controlled door locks OFF
1-4	Ignition controlled door unlock ON	Ignition controlled door unlock OFF
1-5	Active locking	Passive locking
1-6	Panic with ignition on	No panic with ignition on
1-7*	0.8 second door lock pulses	3.5 second door lock pulses/0.4 sec.
1-8	Forced passive arming ON	Forced passive arming OFF
1-9	Automatic Engine Disable ON	Automatic Engine Disable OFF
1-10	Vehicle Recovery System (VRS®) ON	(VRS®) OFF
1-11	Code Hopping® on	Code Hopping® off

Note: For feature number 1-7, the 3.5 second door lock pulse setting the siren will chirp twice, the 0.4 second door lock pulse setting the siren will chirp three times.

Menu #2 - Advanced Features

Feature Number	One Chirp Setting	Two-Chirp Setting
2-1	Multi-Level Arming (progressive)	(grouped, off)
2-2	30-second siren duration	60-second siren duration
2-3	Nuisance Prevention® Circuitry (On)	Nuisance Prevention® Circuitry (Off)
2-4	Progressive door trigger	Instant door trigger
2-5	Valet button input: (1 pulse)	Valet button input: (2-5 pulses)
2-6	Bypass Notification (ON)	Bypass Notification (OFF)
2-7	Enhanced Domelight Control (Full)	(door only, ignition only, Off)
2-8	Single unlock pulse	Double unlock pulse
2-9	Single lock pulse	Double lock pulse
2-10	Comfort Closure (On)	Comfort Closure (Off)
2-11	Immobilizer Circuit (normally closed)	Immobilizer Circuit (normally open)
2-12	Hood Trigger (normally closed)	Hood Trigger (normally open)
2-13	Dual Sensor Type (On)	Dual Sensor Type (Off)
2-14	High Security Disarm (On)	High Security Disarm (Off)

Menu #3 - Advanced Features

Note: Some of the features described below are only available with the Bitwriter®

Feature Number	One Chirp Setting	Two-Chirp Setting
3-1	Horn (pulsed)	Horn (constant)
3-2	Horn Function (full alarm only)	Siren function—chirp length (20mS, 30mS, 40mS, 50mS)
3-3	Factory Disarm with Channel 2 (On)	Factory Disarm with Channel 2 (Off)
3-4	Ground When Armed in Valet® (On)	Ground When Armed in Valet® (Off)
3-5	Channel 3: Validity	latched/latched, reset with ignition/30-second/60-second/90-second timed/remote start report
3-6	Channel 3: Linking (none)	Arm, Disarm, both
3-7	Channel 4: Validity	latched/latched, reset with ignition/30-second/60-second/90-second timed
3-8	Channel 4: Linking (none)	Arm, Disarm, both
3-9	Channel 5: Validity	latched/latched, reset with ignition/30-second/60-second/90-second timed
3-10	Channel 5: Linking (none)	Arm, Disarm, both
3-11	Channel 6: Validity	latched/latched, reset with ignition/30-second/60-second/90-second timed
3-12	Channel 6: Linking (none)	Arm, Disarm, both
3-13	Parking Light Supervision (On)	Parking Light Supervision (Off)
3-14	Ignition Controlled 2nd Unlock (Progressive)	Ignition Controlled 2nd Unlock (Immediate - with first unlock)

Bitwriter Features

Feature Description	Settings (factory default in bold)
Siren Duration	1–180 seconds (30 seconds)
Channel 3 Timed	1–90 seconds (30 seconds)
Channel 4 Timed	1–90 seconds (30 seconds)
Channel 5 Timed	1–90 seconds (30 seconds)
Channel 6 Timed	1–90 seconds (30 seconds)
Zone 2 Shock adjust	level 0–20

Feature Descriptions

The features of the system are described below. Features that have additional settings that can be selected only when programming with the 998T Bitwriter® are indicated by the following icon:



Menu #1 - Basic Features

1-1 ACTIVE/PASSIVE ARMING: When active arming is selected, the system will only arm when the transmitter is used. When set to passive, the system will arm automatically 30 seconds after the last door is closed. To alert the consumer of passive arming, the siren will chirp 20 seconds after the door is closed. This provides the consumer with an audible indication prior to the system actually arming. At the 30 second mark, the system will arm but the siren will not chirp.

1-2 CHIRPS ON/OFF: This feature controls the chirps that confirm the arming and disarming of the system.

1-3 IGNITION CONTROLLED DOOR LOCK ON/OFF: When turned on, the doors will lock three seconds after the ignition is turned on, if the doors are closed.

1-4 IGNITION CONTROLLED DOOR UNLOCK ON/OFF: When turned on, the doors will unlock when the ignition is turned off.

1-5 ACTIVE/PASSIVE LOCKING: If passive arming is selected in menu item 1-1, then the system can be programmed to either lock the doors when passive arming occurs, or only lock the doors when the system is armed via the transmitter. Active locking means the system will not lock the doors when it passively arms. Passive locking means that the system will lock the doors when it passively arms.

NOTE: Remember, when passive arming is selected, the unit will chirp 20 seconds after the last door is closed. The system does not actually arm or lock the doors until 30 seconds after the door has been closed.

1-6 PANIC WITH IGNITION ON: This step controls whether or not the Panic Mode is available with the ignition on. In some states, there are laws prohibiting a siren from sounding in a moving vehicle. This feature makes the system compliant with these regulations.

1-7 DOOR LOCK PULSE DURATION: Some European vehicles, such as Mercedes-Benz and Audi, require longer lock and unlock pulses to operate the vacuum pump. Programming the system to provide 3.5 second pulses, will accommodate the door lock interface in these vehicles. The default setting is 0.8 second door lock pulses. For some vehicles a 0.4 second pulse duration is required, this duration is required for some vehicles to prevent the windows from moving.

1-8 FORCED PASSIVE ARMING ON/OFF: To use this feature, passive arming must be selected in menu item 1-1. When turned on, forced passive arming will ensure that the system will passively arm, even if a zone is left open or invalid. Forced passive arming occurs one hour after the ignition is turned off.

1-9 AUTOMATIC ENGINE DISABLE (AED) ON/OFF: AED is a full-time, passive starter disable that works independently of the security system. When turned on, the starter immobilizer circuit will go active 30 seconds after the ignition is turned off. The LED will flash at half its normal rate when the ignition is turned off to indicate that AED is active and will interrupt the starter in 30 seconds. AED does not occur in Valet mode and can be bypassed using the emergency override procedure. The transmitter can also be used to disarm AED.

1-10 VEHICLE RECOVERY SYSTEM: If Vehicle Recovery System (VRS[®]) is programmed to the ON setting, VRS[®] can be activated by the user. Refer to the *Owner's Guide* for additional description.





1-11 CODE-HOPPING™ ON/OFF: The system uses a mathematical formula to change its code each time the transmitter and receiver communicate. This makes the group of bits or “word” from the transmitter very long. The longer the word is, the easier it is to block its transmission to the unit. Disabling the Code-Hopping™ feature lets the receiver ignore the Code-Hopping™ part of the transmitted word. As a result, the unit may have better range with Code-Hopping™ off.

Menu #2 - Advanced Features

2-1 MULTI-LEVEL ARMING: The system can be programmed to bypass selected zones or groups of zones when armed or to have multi-level arming off. The parking light flashes provide the indication for the zones or groups selected to be bypassed.

Progressive Multi-Level Arming



After arming, immediately press the ARM  button again to enter multi-level arming.

Press  button once	2 light flashes	Zone 2 bypassed
Press  button twice	3 light flashes	Zone 4 bypassed
Press  button three times	4 light flashes	Zone 7 bypassed
Press  button four times	5 light flashes	Zone 2 and 4 bypassed
Press  button five times	6 light flashes	Zone 2 and 7 bypassed

Press  button six times 7 light flashes Zone 4 and 7 bypassed

Press  button seven times 8 light flashes All zones except zone 5 are bypassed

NOTE: Multi-Level Security Arming only applies to a single arming cycle. Once the system is disarmed and then re-armed, all the zones will be active again.

After each press of the  to reach the next level of security, the 2-way LED remote will emit normal arm notification (1 beep and 3 flashes of the Orange LED). For easiest operation in reaching each level of security, press  immediately after each notification.

Grouped Multi-Level Arming

After arming, immediately press the  button once. The parking lights will flash 3 times and all the sensor warn-away zones will be bypassed.

After arming, immediately press the  button twice. The parking lights will flash 4 times and all the sensor warn-away and full alarm zones will be bypassed. All remaining zones are still active.

Multi-Level Off

No zones are bypassed. Pressing arm  again will repeat the arm output, and the unit will remain in the armed state.

2-2 SIREN DURATION 30/60 SECONDS: It is possible to program the unit to sound for 30 or 60 seconds during the triggered sequence. Some states have laws regulating how long a security system can sound. When using the 998T Bitwriter®, the siren can be programmed to sound for any length of time ranging from 1 to 180 seconds. Using the SELECT button of the 998T Bitwriter® will adjust the siren duration in one second increments.

2-3 NUISANCE PREVENTION® CIRCUITRY (NPC®) ON/OFF: NPC® stops repeated triggering of the same zone. If one zone is triggered three times in one hour, that zone is bypassed for one hour, starting from the time of the third trigger. During that hour, if the system detects a trigger on that zone again, the system resets the one hour timer. If one hour passes and the zone has not triggered again, the zone is activated and can trigger the system again. NPC® monitors sensor inputs and the door trigger, but does not bypass the ignition trigger at any time. If NPC® is turned off, the system will respond to repeated triggers on the sensor inputs and will do so indefinitely. Some states have laws regulating how many times a security system can trigger before it is considered a nuisance and the vehicle is towed away.

2-4 PROGRESSIVE DOOR TRIGGER ON/OFF: The system responds to a door trigger input with a progressive response. When the door is opened with the system armed, the siren will chirp 10 times prior to the full triggered sequence. The door trigger is still treated as an instant trigger and closing the door quickly will not prevent a full triggered sequence from occurring. If the progressive door trigger is programmed off, the full siren output will occur when the door is opened.

2-5 VALET PULSE COUNT ONE TO FIVE PULSES: The system can be programmed to count the number presses of the valet button before disarming the security system or VRS®. The factory default setting is one pulse. The unit can be set for two to five pulses using the two-chirp setting to select the pulse count.

Ghost Switch Option: For added security, the GRAY wire on the two-pin Valet/Program can be connected to any switch in the vehicle that provides a positive (+) momentary pulse.

2-6 BYPASS NOTIFICATION ON/OFF: When programmed On, zone 3 input to the system during arming will generate a bypass notification chirp, if active. When programmed OFF, no bypass notification chirps will be generated if zone 3 is active during arming.

2-7 ENHANCED DOMELIGHT CONTROL: This feature has four possible settings: Full, Door Controlled, Ignition Controlled, and None. The optional domelight supervision feature must be installed. These function as follows:

FULL: The system incorporates both Door Controlled and Ignition Controlled features (described below).



DOOR CONTROLLED: If turned on, a 30-second timer will start after the door has been opened and then closed. If the door trigger (door open) remains active for longer than 180-seconds, the timer will not activate for this cycle. If the ignition is activated, the timer will stop.

IGNITION CONTROLLED: If turned on, the system will turn on the domelight for 30 seconds when the ignition is turned off.

NONE: The system will provide dome light output as a pulsed full trigger output and for 30-seconds after the system is disarmed.

2-8 DOUBLE/SINGLE PULSE UNLOCK: Some vehicles require two pulses on a single wire to unlock the doors. When the double pulse unlock feature is turned on, the BLUE/BLACK H2/F wire will supply two pulses instead of a single pulse. This makes it possible to directly interface with double pulse vehicles without any extra parts.

2-9 *DOUBLE/SINGLE PULSE LOCK*: Some vehicles require two pulses on a single wire to lock the doors. When the double pulse lock feature is turned on, the GREEN/BLACK H2/C wire will supply two pulses instead of a single pulse. This makes it possible to directly interface with double pulse vehicles without any extra parts.

2-10 *COMFORT CLOSURE*: The system can be programmed to close the windows when the system is armed. A 20-second output starts 200mS after the last lock  pulse. The Comfort Closure output will be canceled if the unlock  button is pressed. If programmed, the lock output wire will provide this function.

NOTE: Comfort Closure is deleted if one-time bypass is activated.

2-11 *IMMOBILIZER NORMALLY CLOSED/NORMALLY OPEN*: When programmed to the Normally closed position, the car can be started if power to the alarm is removed for service.

2-12 *HOOD TRIGGER NORMALLY CLOSED/NORMALLY OPEN*: To program the unit for either a normally closed or normally open pin switch.

2-13 *DUAL SENSOR TRIGGER ON/OFF*: When programmed On any two sensors (zones 2, 4, 7) need to be triggered within 1-second of each other to trigger the alarm/siren. When programmed Off each sensor will trigger the alarm/siren independently.

NOTE: When On Multi-Level Arming is defeated.

2-14 *HIGH SECURITY DISARM ON/OFF*: When programmed On the system will silence the siren on the first press of the unlock button and disarm/unlock on the second press of the unlock button. When programmed Off (or within 5-seconds of alarm triggering when programmed On) the system will disarm and unlock on the first press of the unlock button.

Menu #3 - Advanced Features

3-1 *HORN (PULSED)/HORN (CONSTANT)*: Program for either a pulsed output or a continuous output when triggered.

3-2 *HORN FUNCTION (FULL ALARM ONLY)/SIREN FUNCTION (20mS, 30mS, 40mS, 50mS)*: Program for output when the alarm is fully triggered or as the siren (arming/disarming and warnaway and full trigger with timing options).

3-3 *FACTORY DISARM WITH CHANNEL 2 (ON)/FACTORY DISARM WITH CHANNEL 2 (OFF)*: The factory alarm disarm wire sends out a pulse when activating channel 2 output.

3-4 GROUND WHEN ARMED IN VALET (ON)/GROUND WHEN ARMED IN VALET (OFF): Provides On/Off programming for the Ground When Armed wire output when locking the car while in Valet mode.

3-5 CHANNEL 3 VALIDITY (ON)/LATCHED/LATCHED, RESET WITH IGNITION/30-SECOND/60-SECOND/90-SECOND TIMED/REMOTE START REPORT: Channel 3 can be programmed for these output configurations. The unit is set to the default validity output. To change the configuration, use the two-chirp setting to toggle to the different configurations.

NOTE: Reference H2/4 discussion.

Remote Start ON Report—When programmed ON and when Channel 3 is transmitted and Zone 1 is grounded, the system will:

Zone 1 will bypass, Zone 3 will monitor and bypass input, all sensor zones will be bypassed, the starter kill activates for anti-grind protection, the ESP will transmit Remote Start ON to HHU (note: no transmission on this model), and the Factory Alarm Disarm will output immediately after receiving a remote start operation.

Remote start OFF report: When programmed on, and ground on, zone 1 ceases and the system will:

Zone 3 will monitor any bypass (same as door trigger), all sensor zones will be re-activated, the starter kill releases if the system is not armed, and the ESP will transmit Remote Start OFF to HHU (note: no transmission on this model).

3-6 CHANNEL 3 LINKING (NONE)/ARM, DISARM, BOTH: When programming to validity or timed output this can be programmed to activate when arming or disarming (or both) with the transmitter.

3-7 CHANNEL 4 VALIDITY (ON)/LATCHED/LATCHED, RESET WITH WITH IGNITION/30-SECOND/60-SECOND/90-SECOND TIMED: Refer to discussion for H2/4.

3-8 CHANNEL 4 LINKING (NONE)/ARM, DISARM, BOTH: See Feature 3-6.

3-9 CHANNEL 5 VALIDITY (ON)/LATCHED/LATCHED, RESET WITH WITH IGNITION/30-SECOND/60-SECOND/90-SECOND TIMED: Refer to discussion for H2/4.

3-10 CHANNEL 5 LINKING (NONE)/ARM, DISARM, BOTH: See Feature 3-6.

3-11 CHANNEL 6 VALIDITY (ON)/LATCHED/LATCHED, RESET WITH WITH IGNITION/30-SECOND/60-SECOND/90-SECOND TIMED: Refer to Feature 3-5.

3-12 CHANNEL 6 LINKING (NONE)/ARM, DISARM, BOTH: See Feature 3-6.

3-13 PARKING LIGHT SUPERVISION (ON)/PARKING LIGHT SUPERVISION (OFF):
When programmed ON the parking lights will illuminate for 30-seconds after disarming the system, or turning off the ignition.

3-14 IGNITION CONTROLLED 2ND UNLOCK (PROGRESSIVE)/IGNITION CONTROLLED 2ND UNLOCK (IMMEDIATE - WITH FIRST UNLOCK): When Progressive 2nd unlock is ON the 2nd unlock activates after the 1st unlock. When Immediate is ON the 2nd unlock occurs at the same time as the 1st unlock.

Transmitter/Receiver Learn Routine

The system comes with two transmitters (one 2-way and one 1-way remote) that have been taught to it. The system can store up to four different transmitter codes in memory. Use the following learn routine to add transmitters to the system or to change button assignments if desired.

If the system was previously programmed using the 998T Bitwriter[®], the learn routine may be locked. If the siren generates one long chirp when attempting to program the unit, the learn routine is locked and must be unlocked using the 998T Bitwriter[®] before proceeding.



1. **Open a door.** (The GREEN wire, H1/5, or the VIOLET, H1/6 must be connected.)



2. **Turn the ignition on.** (The YELLOW wire, H1/9 must be connected.)



3. **Select the receiver channel:** Press and release the Valet/Program button the number of times necessary to access the desired channel.

NOTE: If adding a remote, a button must be taught to the unit in the Channel 1 or Channel 4 position prior to programming other channels.

Press and hold the Valet/Program button once more. The siren will chirp and the LED will blink the number of times corresponding to the channel that is accessed.

Valet Step	Function	Wire Color
1	Auto/Learn Standard	
2	Lock/Arm/Panic On/Panic Off	
3	Unlock/Disarm/Panic Off	
4	Channel 2	RED/WHITE
5	Channel 3	WHITE/BLUE
6	Channel 4	VIOLET/BLACK
7	Channel 5	WHITE/BLACK
8	Channel 6	GRAY/BLACK
9	Arm/Disarm/Panic	
10	Panic Only	
11	Delete All Transmitters	

*NOTE: For Auto Learn Configurations, see *Transmitter Configurations* section of this guide.



4. **Press the transmitter button:** While holding the Valet/Program button, press the button from the transmitter that you wish to assign to the selected channel. The unit will chirp indicating successful programming. It is not possible to teach a transmitter button to the system more than once.

Channel #11: If any button from a known transmitter is programmed to Channel 11, all transmitters will be erased from memory and the system features will revert to the default settings. This is useful in cases where one of the customer's transmitters is lost or stolen. This will erase any lost or stolen transmitters from the system's memory. It can also be used to start from scratch if the transmitter buttons were programmed incorrectly.



5. **Release.** Once the code is learned, the Valet/Program button can be released.

To exit the learn routine:

One long chirp indicates that Learn Routine has been exited. Learn Routine will be exited if any of the following occurs:













- Ignition is turned off.
- Door is closed.
- Valet/Program button is pressed too many times.
- More than 15 seconds elapse between steps.

Transmitter Configurations

The Auto Learn functions in the Transmitter/Receiver Learn Routine will program the transmitter buttons to the following configuration.

Standard Configuration (2-Way LED Remote)

When programmed for standard configuration, the transmitter buttons are assigned to the following functions:

	operates	Lock, Arm/Panic On/Panic Off
	operates	Unlock, Disarm/Panic Off
	operates	Channel 2 and Silent Mode
	operates	Panic On/Off
 and 	operate	Channel 3
 and 	operate	Channel 4
 and 	operate	Channel 5
 and 	operate	Channel 6

Shock Sensor Adjustment

Note: This procedure only adjusts the on-board Zone 2 shock sensor.

Enter Shock Sensor Adjustment Mode



IMPORTANT! The system must be disarmed, and doors and other protected entries (zones 1 and 6) must be closed, and ignition (zone 5) must be off.

1. Press and hold **AUX** and  buttons for 6-seconds.
2. The system will emit 1 long chirp to indicate entry into shock adjustment mode.
3. The LED will illuminate continuously for the duration of shock adjustment mode.

Note: When the shock sensor adjustment mode is entered, all other timers and operations are bypassed until adjustment mode is exited.

Adjusting the Shock Sensor Setting

Note: When adjusting the shock sensor, ensure that the vehicle's doors are closed.

1. **Increase Sensitivity**—Press and release the  button to increase shock sensor sensitivity by one step. The siren will chirp 2-times for each step increased in adjustment. When the shock sensor adjustment reaches maximum sensitivity the siren will emit 2 short chirps and then 1 long chirp.
2. **Decrease Sensitivity**—Press and release the  button to decrease shock sensor sensitivity by one step. The siren will chirp 1-time for each step decreased in adjustment. When the shock sensor adjustment reaches minimum sensitivity (sensor is Off) the siren will emit 1 short and then 1 long chirp.
3. **Testing Sensor**—Use the heel of the palm of your hand to strike the door pillar of the car after any increase or decrease in adjustment. The siren will chirp once if the impact was great enough to generate a full trigger. Pre-warn level is set automatically. When desired setting is reached, sensor adjustment mode can be exited.

Exit Shock Sensor Adjustment Mode



The adjustment mode will be exited if:

- No input from transmitter for 15-seconds.
- No input from sensitivity testing for 15-seconds.
- The ignition is turned On.
- The Valet button is pressed.

The siren will emit 1 long chirp and the LED will extinguish which shock adjustment mode is exited.

Reset Shock Sensor to Default Setting

The shock sensor can be restored to a default setting of 10 to facilitate re-adjustment at any time while in adjustment mode.

1. Simultaneously press the  and  buttons.
2. The system will emit 3 chirps to indicate the sensor has been reset to level 10.
3. The system returns to shock sensor adjustment mode for further adjustment, if required.

Diagnostics

The system's microprocessor monitors and reports all active and violated zones when arming and disarming. LED flashes indicate the active or violated zone; siren chirps indicate system status.

Arm/Disarm Diagnostics

The number of siren chirps will indicate the status of the system when arming and disarming. For information on which zone is active or has been violated refer to the *Table of Zones*.

System Status Chirps

Action	Number of Chirps	Description
Arm	1	System armed
Arm	1 (3 second delay), 1	System armed with Bypass Notification
Disarm	2	System disarmed
Disarm	4	System disarmed with Tamper Alert
Disarm	5	System disarmed NPC® active

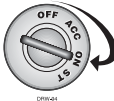

Table of Zones

Zone No.	Trigger type	Input description
1	Instant	H1/7 BLUE wire. Connect to optional hood/trunk pins.
2	Multiplexed	For the onboard shock sensor light impacts will trigger a Warning Zone response, while heavy impacts will instantly trigger the full alarm sequence.
3	Instant Two-stage, or constant	Door switch circuit. H1/8 GREEN or H1/6 VIOLET.
4	Multiplexed Input	Inputs shorter than 0.8 seconds will trigger a Warning Zone response, while inputs longer than 0.8 seconds will instantly trigger the full alarm sequence.
5	Two-stage (similar to doors)	Ignition input. H1/4 YELLOW.
6	Hood trigger	H2/2 GREY
7	Multiplexed input (sensors)	Inputs shorter than 0.8 seconds will trigger a Warning Zone response, while inputs longer than 0.8 seconds will instantly trigger the full alarm sequence.

NOTE: The Warn Away® response does not report on the LED.

Long Term Event History

The system stores the last six full triggers in memory. These are not erasable. Each time the unit sees a full trigger, the oldest of the six triggers in memory will be replaced by the new trigger. To access long term event history:

-  1. With the ignition off, press and HOLD the Valet/Program button.
-  2. Turn on the ignition.
-  3. Release the Valet/Program button.
-  4. Press and release the Valet/Program button within five seconds. The LED will flash in groups indicating the last six zones that triggered the unit. The LED will flash for one minute or until the ignition is turned off.

NOTE: The Warning Zone triggers are not stored to memory and will not be reported.

Multi-Level Security Arming

Multi-Level Security arming allows the operator to select which inputs and sensors are active during a particular arming cycle. For a full description of Multi-Level Security Arming operation for testing purposes refer to the Owner's Guide.

Optional Vehicle Recovery System (VRS®)

VRS® is an optional feature designed to disable a vehicle during a carjacking event. It must be programmed in the features menu and the Failsafe Starter Kill must be installed for it to work properly. For operational instructions when testing VRS® refer to the Owner's Guide.

Nuisance Prevention® Circuitry

Nuisance Prevention® Circuitry bypasses any zone that triggers the system more than three times within a one-hour period. For a full description of NPC® operations refer to the Owner's Guide.

IMPORTANT: When testing the systems sensor and trigger inputs reset NPC® by turning on the ignition after every third system trigger.

Rapid Resume Logic

Rapid Resume Logic ensures that when the system is powered up it will return to the same state it was in when power is disconnected. For a full description of Rapid Resume Logic refer to the Owner's Guide.

Troubleshooting

Starter kill doesn't work.

- Is the correct starter wire being interrupted? If the car starts when the starter kill relay is completely disconnected, the wrong starter wire has been cut and interrupted. Is the NC/NO programmed correctly?
- YELLOW wire is not connected to true ignition. It is connected to an accessory circuit.

Sensors don't trigger the alarm.

- Has the NPC® system been triggered? If so, you will hear five chirps when disarming. To check this, turn the ignition key on and off to clear the NPC® from memory, and then retest the sensors. For a detailed description of NPC®, see Owner's Guide.

Door input does not immediately trigger full alarm. Instead, I hear chirps for the first three seconds.

- That's how the progressive two-stage door input works! This is the instant response feature of this system. Even if the door is closed immediately, the system provides an instant trigger by chirping, and then progressing to a constant siren.

Closing the door triggers the system, but opening the door does not.

- Have you correctly identified the type of door switch system? This happens often when the wrong door input has been used.

System will not passively arm until it is remotely armed and then disarmed.

- Are the door inputs connected? Is a blue H1/7 wire connected to the door trigger wire in the vehicle? Either the green H1/5 or the violet H1/6 should be used instead.

Door input does not respond with the progressive trigger, but with immediate full alarm.

- What zone does the LED indicate? If the LED indicates that the impact sensor caused the trigger, the sensor may be detecting the door opening. Reducing the sensitivity or relocating the sensor can often solve this problem. If the LED indicates that the door caused the trigger, you may have programmed the progressive door trigger off. (See Feature 2-4 in the *Feature Descriptions* section of this guide.)

The Valet button doesn't work.

- Is it plugged into the correct socket? Check the System Features Learn Routine for the programmed Valet pulse count.

Status LED doesn't work.

- Make sure that it is plugged in. (See *Plug-In Harnesses* section of this guide.) Is the LED plugged into the correct socket?

Wiring Quick Reference Guide

