

Responder LE Models Viper Clifford Python Security System Installation Guide

This product is intended for installation by a professional installer only! Attempts to install this product by a person other than a trained professional may result in severe damage to a vehicle's electrical system and components.

Directed[®]
E L E C T R O N I C S

© 2009 Directed Electronics, Vista, CA
N3203 2009-12

Bitwriter®, Code Hopping™, Doubleguard®, ESP™, Fail-Safe®, Ghost Switch™, Learn Routine™, Nite-Lite®, Nuisance Prevention® Circuitry, Revenger®, Silent Mode™, Soft Chirp®, Stinger®, Valet®, Vehicle Recovery System®, VRS®, and Warn Away® are all Trademarks or Registered Trademarks of Direct Electronics.



The Bitwriter® (p/n 998U) requires chip version 2.7 or newer to program this unit.

Bitwriters with a date code of 6a or older require an IC upgrade (p/n 998M). Some bitwriters with a date code of 6B do not require the IC upgrade, refer to tech tip # 1112 for more information.



Contents

Warning! Safety First.....	4
Wiring Diagram	4
Wiring Connections	5
Main Harness (H1), 12-pin connector	5
Door Lock Harness (H2), 8-pin connector	5
Auxiliary Harness (H3) 7-pin connector.....	5
Starter Kill Harness, 3-pin connector	5
GWA Mux Harness, 3-pin connector	6
Adjusting the Shock Sensor	6
Pairing a 1-way or 2-way Remote Control	6
Programming System Features	7
Feature Menus	8
Menu 1	8
Menu 2.....	11
Bitwriter - Only Options	14
Basic Remote Functions	16
Reset and Deletion	16
Long Term Event History	16
Table of Zones	17
Troubleshooting: Alarm	17

Warning! Safety First



The following safety warnings must be observed at all times:

- Due to the complexity of this system, installation of this product must only be performed by an authorized Directed Electronics dealer.

The following precautions are the sole responsibility of the user; however, authorized Directed Electronics dealers should:

- Never use a test light or logic probe when installing this unit. Always use a multimeter.

Use of this product in a manner contrary to its intended mode of operation may result in property damage, personal injury, or death.

Wiring Diagram

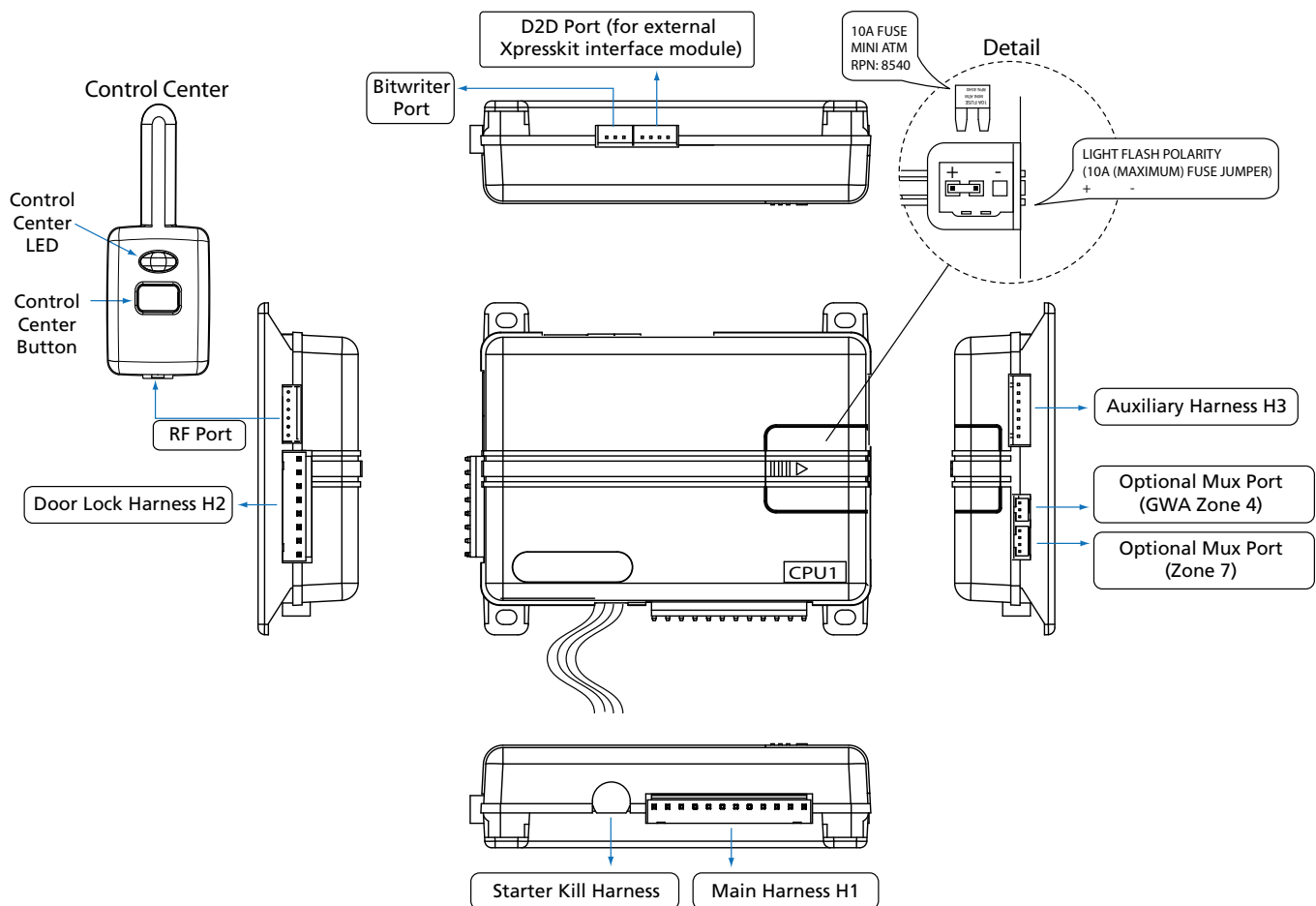

Wiring Connections

Main Harness (H1), 12-pin connector

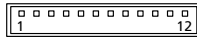

H1/1	RED/WHITE	(-) 200mA AUX/TRUNK OUTPUT
H1/2	RED	(+) 12VDC CONSTANT INPUT
H1/3	BROWN	(+) SIREN OUTPUT
H1/4	WHITE/BROWN	PARKING LIGHT ISOLATION WIRE - PIN 87a of onboard relay
H1/5	BLACK	(-) CHASSIS GROUND
H1/6	VIOLET	(+) DOOR TRIGGER INPUT
H1/7	BLUE	(-) TRUNK PIN/ INSTANT TRIGGER INPUT (N/C OR N/O)
H1/8	GREEN	(-) DOOR TRIGGER INPUT (N/C* OR N/O)
H1/9	BLACK/WHITE	(-) 200mA DOME LIGHT SUPERVISION/FLEX RELAY (Programmable) OUTPUT
H1/10	WHITE/BLUE	200 mA AUX 1 OUTPUT
H1/11	WHITE	PARKING LIGHT OUTPUT
H1/12	ORANGE	(-) 500mA GROUND WHEN ARMED OUTPUT

*When using the normally closed setting, this wire only covers one door. Use auxiliary outputs 2, 3 or 4 (as necessary) programmed as N/C door switch inputs (wired to each individual door of the vehicle) to cover the other doors. The auxiliary outputs are also programmable as N/O door switch inputs so you can connect multiple doors without the use of diodes.

When the auxiliaries are programmed for these types of circuits and connected to the vehicle, the alarm reports a door violation when triggered.

Door Lock Harness (H2), 8-pin connector



H2/1	VIOLET*	UNLOCK #87 NORMALLY OPEN (INPUT)
H2/2	BLUE/BLACK	UNLOCK #30 COMMON (OUTPUT)
H2/3	BROWN/BLACK	UNLOCK #87a NORMALLY CLOSED
H2/4	VIOLET/BLACK*	LOCK #87 NORMALLY OPEN (INPUT)
H2/5	GREEN/BLACK	LOCK #30 COMMON (OUTPUT)
H2/6	WHITE/BLACK	LOCK #87a NORMALLY CLOSED
H2/7	WHITE/VIOLET	FLEX RELAY #87 NORMALLY OPEN (INPUT)**
H2/8	WHITE/BROWN	FLEX RELAY #87a NORMALLY CLOSED**

* Violet and Violet/Black are common at the fuse holder.

** These wires work in conjunction with the Black/white H1/9 wire. The white/violet determines what the polarity of the H1/9 wire will be and the white/brown will only be used if a five wire circuit is required.

Auxiliary Harness (H3) 7-pin connector



H3/1	ORANGE/BLACK	(-) 200mA AUX 4 OUTPUT
H3/2	WHITE/BLACK	(-) 200mA AUX 3 OUTPUT
H3/3	VIOLET/BLACK	(-) 200mA AUX 2 OUTPUT
H3/4	LIGHT GREEN/BLACK	(-) 200mA FACTORY ALARM DISARM OUTPUT
H3/5	YELLOW	(+) IGNITION INPUT
H3/6	BROWN	(-) 200mA HORN HONK OUTPUT
H3/7	GREY	(-) HOOD PIN INPUT (N/C OR N/O)

Starter Kill Harness, 3-pin connector



1	GREEN/WHITE	STARTER - COMMON (KEY SIDE)
2	GREEN	STARTER - NORMALLY OPEN (MOTOR SIDE)

3	GREEN/BLACK	STARTER - NORMALLY CLOSED (MOTOR SIDE)
---	-------------	----------------------------------------

GWA Mux Harness, 3-pin connector

1	RED	+12 VDC TO SENSOR
2	BLACK	GND TO SENSOR
3	BLUE/WHITE	MUX WIRE INPUT

Adjusting the Shock Sensor

Adjusting with a 1-way and 2-way remote control:

Note: The remote control may or may not emit sounds during this operation.

1. Disarm the system, turn the ignition off and close all the doors, hood and trunk.
2. Press and hold the **f** button of the remote control for 8 seconds until the transmit LED turns on and then release it (If programmed to operate two systems, ignore the transmit LED flashes at 3 seconds).
3. Press and hold the **🔒** button until the transmit LED flashes off then on and the siren emits a long chirp. Adjustment mode is ready.
4. Adjust the sensitivity:
 - Press and release the **🔒** button to increase the sensitivity. The siren chirps two times.
 - Press and release the **🔓** button to decrease the sensitivity. The siren chirps one time.
 - Press and release the **🔄** button to reset sensitivity to default setting. The siren chirps three times.

Note: After each adjustment the sensitivity can be tested by cautiously impacting the vehicle with increasing intensity. The siren will chirp to indicate the impact level required to fully trigger the alarm.

Exit adjustment mode:

- Press and release the **f** button any time to exit adjustment mode, and then press and hold to return the remote control to normal operation (transmit LED turns off).
- Open the hood or trunk
- Turn the ignition on
- Wait for 30 seconds between steps

The siren will emit one long chirp when exiting adjustment mode.

Pairing a 1-way or 2-way Remote Control

Note: The remote control may or may not emit sounds during this operation.

Prepare the vehicle

1. Open a door.
2. Turn the ignition on.
3. Press and release then press and hold the control center button. The control center LED flashes and siren chirps one time to confirm the system is prepared.
4. Release the button and proceed below.

Note: Begin pairing within 60 seconds or the system will exit (indicated by a long siren chirp) and will need to be prepared again.

Prepare the remote control

Select the desired car 1 (default) or car 2 operation before proceeding.

1. Press and hold the **f** button of the remote control for 8 seconds until the transmit LED turns on, and then release it (If programmed to operate two systems, ignore the transmit LED flashes at 3 seconds).
2. Press and hold the **🔄** button until the transmit LED flashes off and on three times.
3. Press and hold the **🔒** button until the siren emits one long chirp to confirm Pairing.

Note: 2-way remote controls MUST also emit a sequence of chimes to confirm pairing is successful. If not heard, make sure the system is still prepared and repeat step 3 until successful.

To exit Pairing mode:



1. Turn off the ignition, the siren will emit one long chirp.
2. Press and hold the **f** button on the remote and then press and hold to return the remote control to normal operation (transmit LED turns off).

Programming System Features

The System Features Learn Routine dictates how the unit operates. It is possible to access and change most of the feature settings using the Control button.

1. Open a door.
2. Turn the ignition on, then off.
3. Select a Menu. Press and hold the Control button. The number of siren chirps indicates the menu number. 1 chirp indicates menu 1, 2 chirps for menu 2.
4. When the desired menu chirps are heard, release the Control button.
5. Select a Feature. Press and release the Control button the number of times corresponding to the feature you wish to change. Then press and hold one more time to select the features.
6. Program the Feature. While holding the Control button, you can program the feature using the remote control.

For features with only two options;  = option 1 while  = option 2.

For features with more than two options;  selects the options in ascending order, while  selects them in descending order.

Note: Pressing  button resets the feature to the factory default.

Once a feature is programmed:

- Other features can be programmed within the same menu
- Another menu can be selected
- The learn routine can be exited if programming is complete

To access another feature in the same menu:

1. Press and release the Control button the number of times necessary to advance from the feature you just programmed to the next one you want to program.
2. Then press the Control button once more and hold it.

To select another menu:

1. Press and hold the Control button.
2. After 3 seconds, the unit advances to the next menu and the siren chirps, indicating which menu has been accessed.

The learn routine exits if any of the following occurs:

- The open door is closed
- The ignition is turned On
- There is no activity for 30 seconds
- The Control button is pressed too many times

Feature Menus

Default settings are Opt. 1.

Menu 1

Menu Item	Feature	Opt. 1	Opt. 2	Opt. 3	Opt.4	Opt. 5+
1	System Arming Mode	Active	Passive Arm – no lock	Passive Arm & lock	Auto Re-arm - no lock	Auto Re-arm & Lock
2	Panic Mode	On	Ignition Off Only	Off		
3	Confirmation Chirps	On - Warn chirps on	On - Warn chirps off	Off - Warn chirps on	Off - Warn chirps off	
4	Siren Duration	30 sec.	60 sec.			
5	Ign-controlled Locks	No Ign- locking	Lock & Unlock	Lock Only	Unlock Only	
6	Door Lock Pulses	Single	Double Unlock Only	Double Lock Only	Double Lock & Unlock	
7	Door Lock Output Duration	0.8 sec.	3.5 sec.	0.4 sec.		
8	2nd Unlock**	2nd unlock on Ign-control after first unlock	2nd unlock on Ign-control with first unlock			
9	Comfort Closure	No Comfort Closure	Comfort Closure 1	Comfort Closure 2		
10	Horn Function	Full Alarm Only	Siren Function 20 ms	Siren Function 30 ms	Siren Function 40 ms	Siren Function 50 ms
11	Hood Switch type	Normally Open	Normally closed			
12	Trunk Switch Type	Normally open	Normally closed			
13	Door Switch Type	Normally open	Normally closed			
14	Immobilizer Type	Normally Closed	Normally Open			
15	Sensor Trigger	Single sensor	Double sensor			
16	Nuisance Prevention	On	Off			
17	Flex Relay	Dome	Horn	Trunk release		
18	VRS	Off	On - Disarm chirps off	On - Disarm chirps on		
19	Remote Button unlock (Ign off) *	On	Off			

* Not available with the 1-way remote control.

** Requires 2nd unlock option to be set for an Aux channel.

1. System Arming mode
 1. Active: the transmitter must be used to arm the system
 2. Passive Arm w/o lock: after exiting the vehicle the system will automatically arm. The doors will not lock
 3. Passive Arm w/lock: after exiting the vehicle the system will automatically arm and lock the doors
 4. Auto re-arm w/o lock: if the vehicle is not entered after receiving a disarm command, the system will automatically re-arm. The doors will not lock
 5. Auto re-arm w/lock: if the vehicle is not entered after receiving a disarm command, the system will automatically re-arm and lock the doors
2. Panic Mode
 1. On: the Panic output can be activated at any time
 2. Ign Off Only : the Panic output can be activated only when the ignition is off
 3. Off: the Panic output is defeated
3. Confirmation Chirps
 1. On w/Warn Chirps On: arm, disarm, and sensor warn-away chirps are active
 2. On w/Warn Chirps Off: arm and disarm chirps are active, warn-away chirps are defeated
 3. Off w/Warn Chirps On: arm and disarm chirps are defeated, warn-away chirps are active
 4. Off w/Warn Chirps Off: arm, disarm, and sensor warn-away chirps are defeated
4. Siren Duration
 1. 30sec: the siren output for full trigger activations and Panic mode is 30 seconds
 2. 60sec: the siren output for full trigger activations and Panic mode is 60 seconds
5. Ign-controlled Locks
 1. No Ign-locking: the door lock/unlock outputs will not activate when ignition is turned on/off
 2. Lock & Unlock: the door lock & unlock output will activate when ignition is turned on & off
 3. Lock Only: the door lock output will activate when ignition is turned on
 4. Unlock Only: the door unlock output will activate when ignition is turned off
6. Door Lock Pulses
 1. Single: the door lock & unlock outputs will pulse once
 2. Double Unlock only: the unlock output only will pulse twice
 3. Double Lock Only: the lock output only will pulse twice
 4. Double Lock & Unlock: the lock & unlock outputs will pulse twice
7. Door Lock Output Duration
 1. 0.8sec.: the door lock output pulses will be 800ms in duration
 2. 3.5sec.: the door lock pulses will be 3.5 seconds in duration
 3. 0.4 sec.: the door lock pulses will be 400ms in duration
8. Ignition Controlled 2nd Unlock
 1. After first unlock: for Ign-controlled unlocking, the 2nd unlock will activate 800ms after the first (driver door) unlock
 2. With first unlock: for Ign-controlled unlocking, the 2nd unlock will activate at the same time as the first (driver door) unlock
9. Comfort Closure
 1. No comfort Closure: Comfort Closure is defeated when arming
 2. Comfort Closure 1: the door lock pulse (or 2nd pulse for double pulses) will remain on for 20 seconds.
 3. Comfort Closure 2: 800mS following the end of the door lock pulse (or 2nd pulse for double pulses); the door lock output will turn on again for 20 seconds.
10. Horn Function
 1. Full Alarm Only: the horn output will pulse only during full trigger events.
 2. Siren Function 20/30/40/50ms: The horn output will emulate the siren output with selectable chirp output timing to compensate for OEM horn inefficiency.

11. Hood Switch Type
 1. Normally Open: for vehicles with a hood switch that rests at ground when the hood is OPEN
 2. Normally Closed: for vehicles with a hood switch that rests at ground when the hood is CLOSED
12. Trunk Switch Type
 1. Normally Open: for vehicles with a trunk switch that rests at ground when the trunk is OPEN
 2. Normally Closed: for vehicles with a trunk switch that rests at ground when the trunk is CLOSED
13. Door Switch Type
 1. Normally Open: for vehicles with door switches that rest at ground when the door is OPEN
 2. Normally Closed: for vehicles with door switches that rest at ground when the door is CLOSED
14. Immobilizer Type
 1. Normally Open: the starter kill relay will rest OPEN when main power is disconnected
 2. Normally Closed: the starter kill relay rests CLOSED when main power is disconnected
15. Sensor Full Trigger
 1. Single: full trigger activation of only one sensor is required to fully trigger the alarm
 2. Double: full trigger activation of two sensors within a ten second period is required to fully trigger the alarm.
16. Nuisance Prevention
 1. On: sensors that trigger excessively will be defeated until they have been stable for more than one hour
 2. Off: sensors will not be defeated if triggered excessively
17. Flex Relay
 1. Dome: the (H1/9) Black/White wire will operate as Dome Light Supervision
 2. Horn: the (H1/9) Black/White wire will operate as Horn Honk Output; the (H3/6) Brown wire will operate as Dome Light Supervision.
 3. Trunk: the (H1/9) Black/White wire will operate as Trunk Release Output; the (H1/1) Red/White wire will operate as Dome Light Supervision.
18. VRS
 1. Off: The Vehicle Recovery System is disabled
 2. On – Disarm chirps off: The Vehicle Recovery System is enabled and, when disarmed by Remote Control, will not chirp the siren.
 3. On – Disarm chirps on: The Vehicle Recovery System is enabled and, when disarmed by Remote Control, will chirp the siren 3 times to confirm.
19. Remote Button Unlock (Ign off)
 1. On: a message telling the remote control to unlock the keypad is sent each time the vehicle ignition is turned off
 2. Off: no message is sent

Menu 2

Menu Item	Feature	Opt. 1	Opt. 2	Opt. 3	Opt.4	Opt. 5+
1	One-time Bypass	One time bypass Off	One time bypass On			
2	Override Pulse count	1	2	3	4	5
3	Door Trigger Error Chirp	On	Off			
4	Ign-controlled Dome light	On	Off			
5	OEM Alarm Disarm w/Aux-Trunk	On	Off			
6	OEM Alarm Disarm Output	With Unlock	Before Unlock			
7	OEM Alarm Disarm Pulses	1	2			
8	Aux/Trunk Output type	Validity	Off	OEM Alarm Arm	2nd unlock	
9	Aux/Trunk Linking	No Linking	Link to Arm	Link to Disarm	Link to Arm/Disarm	
10	Aux 1 Output type	Validity	Latch	Latch/reset/ign	Timed	Off (5) OEM Alarm Arm (6), 2nd Unlock (7), Remote Start Report (8)
11	Aux 1 Linking	No Linking	Link to Arm	Link to Disarm	Link to Arm/disarm	
12	Aux 2 Output Type	Validity	Latch	Latch reset/ign	Timed	Off (5) OEM Alarm Arm (6), 2nd Unlock (7), N/O Door Switch (8), N/C Door Switch (9)
13	Aux 2 Linking	No Linking	Link to Arm	Link to Disarm	Link to Arm/Disarm	
14	Aux 3 Output Type	Validity	Latch	Latch reset/ign	Timed	Off (5) OEM Alarm Arm (6), 2nd Unlock (7), N/O Door Switch (8), N/C Door Switch (9)
15	Aux 3 Linking	No Linking	Link to Arm	Link to Disarm	Link to Arm/Disarm	
16	Aux 4 Output Type	Validity	Latch	Latch reset/ign	Timed	Off (5) OEM Alarm Arm (6), 2nd Unlock (7), N/O Door Switch (8), N/C Door Switch (9), Remote Start Report (10)
17	Aux 4 Linking	No linking	Link to Arm	Link to Disarm	Link to Arm/Disarm	
18	Remote Start Button Control	None	Aux 1	Aux 4		

1. One-time Bypass
 1. Off: One-Time Bypass is not available
 2. On: the One-Time Bypass feature will defeat Passive Arming once and, if Armed by remote control, will defeat Comfort Closure and Aux outputs linked to Arming
2. Override Pulse Count
 - 1-5: sets the number of presses (1-5) on the Control Button required to override the alarm system
3. Door Trigger error Chirp
 1. On: if the door trigger is active when arming, the siren will emit a chirp and a message will be sent to the 2way remote control as an alert
 2. Off: an active door trigger when arming will not create an alert output
4. Ign-controlled Dome light
 1. On: the dome light output will activate when the ignition is turned off
 2. Off: the dome light output will not activate when the ignition is turned off
5. OEM Alarm Disarm w/Aux/Trunk
 1. On: the OEM Alarm Disarm wire will pulse as programmed when the Aux/Trunk output is activated
 2. Off: the OEM Alarm Disarm wire will not pulse when the Aux/Trunk output is activated
6. OEM Alarm Disarm Output
 1. With Unlock: the OEM Alarm Disarm wire will pulse as programmed at the same time as the unlock (Blue) wire
 2. Before Unlock: the OEM Alarm Disarm wire will pulse as programmed before the unlock wire
7. OEM Alarm Disarm Pulses
 1. 1: the OEM Alarm Disarm wire will pulse once per operation
 2. 2: the OEM Alarm Disarm wire will pulse twice per operation
8. Aux/Trunk Output Type
 1. Refer to Aux 1 Output Type descriptions
9. Aux/Trunk Linking
 1. Refer to Aux 1 Linking descriptions
10. Aux 1 Output Type
 1. Validity: when the Aux command is received the wire will turn on and remain on until the command ceases
 2. Latch: when the Aux command is received the wire will turn on and remain on until the command is received again
 3. Latch/reset/ignition: when the Aux command is received the wire will turn on and remain on until the command is received again or the ignition is turned on/off
 4. Timed: when the Aux command is received the wire will turn on for the programmed time duration (default 30sec)
 5. Off: the output will not activate for a remote control command, use this option when the Aux command controls an external device such as a garage door module
 6. OEM alarm arm: the output will not activate for a remote control command, it will pulse when the system arms to activate the OEM alarm system.
 7. 2nd unlock: the wire will operate as 2nd unlock and will not activate for remote control commands
 8. Remote start report: the output will pulse once to activate an add-on remote start module and the Trunk Pin wire (H1/7) will be monitored for a ground input to confirm remote start activation.
11. Aux 1 Linking
 1. No Linking: the Aux output will not activate for a remote control command
 2. Link to Arm: the Aux output will activate for the Arm command
 3. Link to Disarm: the Aux output will activate for the Disarm command
 4. Link to Arm/Disarm: the Aux output will activate for the Arm & Disarm commands
 - 5.

12. Aux 2 Output Type
 1. Validity: refer to Aux 1 output type description
 2. Latch: refer to Aux 1 output type description
 3. Latch/reset/Ignition: refer to Aux 1 output type description
 4. Timed: refer to Aux 1 output type description
 5. Off: refer to Aux 1 output type description
 6. OEM alarm arm: refer to Aux 1 output type description
 7. 2nd unlock: refer to Aux 1 output type description
 8. N/O door switch: for vehicles with multiple door switches that rest at ground when the door is OPEN
 9. N/C door switch: for vehicles with multiple door switches that rest at ground when the door is CLOSED



13. Aux 2 Linking
 - refer to Aux 1 Linking description

14. Aux 3 Output Type
 1. Validity: refer to Aux 1 output type description
 2. Latch: refer to Aux 1 output type description
 3. Latch/reset/Ignition: refer to Aux 1 output type description
 4. Timed: refer to Aux 1 output type description
 5. Off: refer to Aux 1 output type description
 6. OEM alarm arm: refer to Aux 1 output type description
 7. 2nd unlock: refer to Aux 1 output type description
 8. N/O door switch: refer to Aux 2 output type description
 9. N/C door switch: refer to Aux 2 output type description

15. Aux 3 Linking
 - refer to Aux 1 Linking description

16. Aux 4 Output Type
 1. Validity: refer to Aux 1 output type description
 2. Latch: refer to Aux 1 output type description
 3. Latch/reset/Ignition: refer to Aux 1 output type description
 4. Timed: refer to Aux 1 output type description
 5. Off: refer to Aux 1 output type description
 6. OEM alarm arm: refer to Aux 1 output type description
 7. 2nd unlock: refer to Aux 1 output type description
 8. N/O door switch: refer to Aux 2 output type description
 9. N/C door switch: refer to Aux 2 output type description
 10. Remote start report: refer to Aux 1 output type description

17. Aux 4 Linking
 1. refer to Aux 1 Linking description

18. Remote start button control
 1. None: The  button has no function
 2. Aux 1: The  button will command Aux 1
 3. Aux 4: The  button will command Aux 4

Bitwriter - Only Options



If programming with the Bitwriter®, the learn routine can be locked or unlocked. If the learn routine has previously been locked, it must be unlocked with Bitwriter® - this cannot be done manually with the Control button.

The Bitwriter®  gives you access to a wider range of system options. These features and the adjustments that may be programmed are described in the table below.

Menu Item	Feature	Default	Opt. 2	Opt. 3	Opt.4	Opt. 5+
1	Siren Duration (Seconds)	30 sec.	Options: 1 to 180 sec.			
2	Shock Sensor Level	7	Options: 0 to 15 in increments of 1			
3	Zone 4 Sensor Icon Type*	None	Shock	Field Disturbance	Tilt Sensor	Glass Break/Ultrasonic/Sensor
4	Zone 7 Sensor Icon Type*	None	Shock	Field Disturbance	Tilt Sensor	Glass Break/Ultrasonic/Sensor
5	Aux/Trunk Icon type*	Trunk	Windows	Sunroof	Audio	Lights/Left dr/Right dr /Rear Hatch
6	Aux 1 Timed Output (Seconds)	30 sec.	Options: 1 to 90 sec.			
7	Aux 1 Icon type*	Pulsed	Trunk	Window	Sunroof	Audio/Lights/Left dr/ Right dr /Rear Hatch/ Timed/ Latched
8	Aux 2 Timed Output (Seconds)	30 sec.	Options: 1 to 90 sec.			
9	Aux 2 Icon type*	Pulsed	Trunk	Window	Sunroof	Audio/Lights/Left dr/ Right dr /Rear Hatch/ Timed/ Latched
10	Aux 3 Timed Output (Seconds)	30 sec.	Options: 1 to 90 sec.			
11	Aux 3 Icon type*	Pulsed	Trunk	Window	Sunroof	Audio/Lights/Left dr/ Right dr /Rear Hatch/ Timed/ Latched
12	Aux 4 Timed Output (Seconds)	30 sec.	Options: 1 to 90 sec.			
13	Feature Programming	Unlocked	Locked			
14	Transmitter Programming	Unlocked	Locked			

* Not available with the Responder LE or 1-way remote control.

1. Siren Duration: sets the Full Trigger output duration in 1 second intervals up to 180 seconds.
2. Sensor 1 level: directly sets the sensor level of the on-board shock sensor
3. Zone 4 Sensor Icon Type: sets the Zone 4 (Sensor 2) name to be displayed in the Text Field for Warn-away and Full Trigger activations
4. Zone 7 Sensor Icon Type: sets the Zone 7 (Sensor 3) name to be displayed in the Text Field for Warn-away and Full Trigger activations
5. Aux/Trunk Icon Type: sets the name to be displayed in the text field when the Aux/Trunk output is activated/de-activated
6. Aux 1 Timed Output: sets the output duration in 1 second intervals up to 90 seconds for Aux 1
7. Aux 1 Icon Type: sets the Accessory name to be displayed in the text field when the Aux 1 output is activated/de-activated
8. Aux 2 Timed Output: sets the Aux 2 "Timed" output in 1 second intervals up to 90 seconds
9. Aux 2 Icon Type: sets the Accessory name to be displayed in the text field when the Aux 2 output is activated/de-activated
10. Aux 3 Timed Output: sets the Aux 3 "Timed" output in 1 second intervals up to 90 seconds
11. Aux 3 Icon Type: sets the Accessory name to be displayed in the text field when the Aux 3 output is activated/de-activated
12. Aux 4 Timed Output: sets the Aux 4 "Timed" output in 1 second intervals up to 90 seconds
13. Feature Programming: locks and unlocks the user's ability to enter the feature menus and manually change the main unit programming using the Control Center
14. Transmitter Programming: locks and unlocks the user's ability to enter the remote control/Reset menu and manually change any functions using the Control Center

Basic Remote Functions

See Owner's guide for functionality details on both the LE and 1-way companion remote control.

Reset and Deletion

If a feature needs to be reset or the remote controls need to be deleted, use the following procedure.

1. Open a door.
2. Turn the ignition to the ON position.
3. Within 10 seconds, press and release the Control button: 2 times if you want to delete remotes or 3 times to reset features. These function steps are described next.

Delete remotes: This feature erases all remotes from the memory of the security system. This is useful in cases when a customer's remote is lost or stolen.

Note: This does not reset the programmed features of the security system.

Reset Features: This resets all features of the security system to the factory default settings.

Note: This feature does not delete the remotes from the security system.

4. Once you have selected the function step, press the Control button once more and hold it. The LED flashes and the siren chirps to confirm the selected functional step. Do not release the Control button
5. While holding the control button, press the  button on the remote control. The unit chirps to confirm that the feature has been successfully reset.

Once the feature is reset, the Control button can be released.

Note: For step 1, the + or - Door Trigger Input wire needs to be connected unless using an interface module that supplies the door trigger through D2D.

Long Term Event History

The system stores the last six full triggers in memory. These are not erasable. To access long term event history:

1. With the ignition Off, press and hold the Control button (on Control Center).
2. Turn the ignition On.
3. Release the Control button.
4. Within 5 seconds, press and release the Control button. The status LED flashes in groups indicating the last six zones that triggered the unit for 1 minute or until the ignition is turned off (indicated in the order of most recent first to oldest last). Refer to *Table of Zones*.

Note: The Warn Away triggers are not stored to memory and is not reported.

Table of Zones

A zone is represented by the number of status LED flashes used by the system to identify a particular type of input.

Zone	Description	Input Description
1	Trunk Pin	H1/7 Blue wire
2	Instant trigger: a heavier impact detected by the onboard shock sensor	On board shock sensor.
3	Door switch trigger	H1/8 Green or H1/6 Violet wire
4	Instant trigger: For optional sensors	3 pin optional GWA MUX port
5	Ignition trigger	H3/5 Yellow wire
6	Hood Pin	H3/7 Grey wire
7	Instant trigger: For optional sensors	4 pin optional MUX port

Troubleshooting: Alarm

Shock sensor doesn't trigger the alarm:

1. Was the onboard shock sensor adjusted before the brain was mounted? If so re-adjust the sensor.
2. Has the onboard shock sensor been turned off? The sensor has the ability to be turned off when adjusting.
3. Has the NPC® system been triggered? If so, you hear 5 chirps when disarming. To check this, turn the ignition key on and off to clear the NPC® memory, and then retest the shock sensor. For a detailed description of NPC®, see Nuisance Prevention Circuitry section of the owners guide.

Door input does not immediately trigger full alarm. Instead, chirps are heard for the first 3 seconds:

- That's how the progressive two-stage door input works! This is a feature of this system even if the door is instantly closed again, the progression from chirps to constant siren continues.

Closing the door triggers the system, but opening the door does not:

- Have you correctly identified the type of door switch system? This happens often when the wrong door input has been used.

System does not passively arm until it is remotely armed and then disarmed:

1. Is passive arming programmed ON?
2. Are the door inputs connected? Is the H1/7 blue wire connected to the door trigger wire in the vehicle? Either the H1/8 green or the H1/6 violet should be used instead.

Door input does not respond with the progressive trigger, but with immediate full alarm:

- Does the Status LED indicate that the trigger was caused by the shock sensor? (See *Table of Zones* section of this guide.) The shock sensor, if set to extreme sensitivity, may be detecting the door unlatching before the door switch sends its signal. Reducing the sensitivity can solve this problem.