

Valet®

Model 712T Installation Guide

NOTE: This product is intended for installation by a professional installer only! Any attempt to install this product by any person other than a trained professional may result in severe damage to a vehicle's electrical system and components.

driven to excel
Directed[®]
ELECTRONICS, INC.

© 2005 Directed Electronics, Inc. Vista, CA
N712T 01-05

Code Hopping®, Doubleguard®, ESP®, FailSafe®, Ghost Switch®, Learn Routine™, Nite-Lite®, Nuisance Prevention® Circuitry, NPC®, Revenger®, Silent Mode™, Soft Chirp®, Stinger®, Valet®, Vehicle Recovery System®, VRS®, and Warn Away® are all Trademarks or Registered Trademarks of Directed Electronics, Inc.

www.directechs.com

DirectFax 800-999-1329 Technical Support 800-753-0800

These resources are for authorized Directed Dealer use only.

Table of Contents

primary harness (H1), 12-pin connector	4
Peripheral Plug-In Harnesses	8
Super Bright LED, 2-Pin WHITE Plug	8
Valet/Program Switch, 2-Pin BLUE Plug	9
System Features Learn Routine	9
System Features Menus	11
Feature Descriptions	11
Transmitter/Receiver Learn Routine	12
Transmitter Configurations	14
Standard Configuration	14
Rapid Resume Logic	14
Wiring Quick Reference Guide	15

primary harness (H1), 12-pin connector

H1/1	RED	(+) 12V CONSTANT POWER INPUT
H1/2	BLUE	(-) 200 mA SECOND UNLOCK OUTPUT
H1/3	BLACK/WHITE-1	INPUT OF DOMELIGHT SUPERVISION RELAY #87
H1/4	BLACK/WHITE	OUTPUT OF DOMELIGHT SUPERVISION RELAY #30
H1/5	GREEN/BLACK	LOCK #30 COMMON OUTPUT
H1/6	WHITE/BLACK	LOCK #87 NORMALLY CLOSED
H1/7	VIOLET/BLACK	LOCK #87 NORMALLY OPEN (INPUT)
H1/8	BLUE/BLACK	UNLOCK #30 COMMON (OUTPUT)
H1/9	VIOLET	UNLOCK #87 NORMALLY OPEN (INPUT)
H1/10	WHITE	(+/-) PARKING LIGHT FLASH OUTPUT
H1/11	BLACK	(-) CHASSIS GROUND INPUT
H1/12	BROWN	(-) HORN HONK OUTPUT
H1/13	LT. GREEN/BLACK	FACTORY ALARM DISARM
H1/14	WHITE/BLUE	(-) 200 mA CHANNEL 3 VALIDITY OUTPUT
H1/15	YELLOW	(+) SWITCHED IGNITION INPUT (ACCESSORY)
H1/16	ORANGE	(-) 500 mA GROUND-WHEN-ARMED OUTPUT
H1/17	BROWN/BLACK	UNLOCK #87A NORMALLY CLOSED
H1/18	RED/WHITE	(-) OUTPUT OF CHANNEL 2

H1/1 RED (+)12V constant power input

Before connecting this wire, remove the supplied fuse. Connect to the battery positive terminal or the constant 12V supply to the ignition switch.

NOTE: Always use a fuse within 12 inches of the point you obtain (+)12V. Do not use the fuse in the harness for this purpose. This fuse protects the module itself.

H1/2 BLUE (-) 200 mA Second Unlock Output

The H1/2 BLUE output is used for progressive unlock. A progressive unlock system unlocks the driver's door when the unlock (disarm) button is pressed and unlocks the passenger doors if the unlock (disarm) button is pressed again within 15 seconds after unlocking the driver's door. The BLUE wire outputs a low current (-) pulse on the second press of the unlock button of the transmitter. This negative unlock output is used to unlock the passenger doors.

H1/3 BLACK/WHITE-1 Domelight Supervision Input

This wire determines what the output polarity of H1/4 will be. If the door pin circuit is negative, connect to chassis ground. If the door circuit is positive, connect to a fused 12V source.

IMPORTANT! The H1/3 wire is not required for wiring the door locks. Depending on the type of door lock system, there may be additional wires for the Door Lock wiring that are not required.

H1/4 BLACK/WHITE Domelight Supervision Output

Connect this wire directly to the domelight circuit in the vehicle. The on-board relay will drive circuits up to 30 amperes. The polarity of this output is determined by the connection of the input wire H1/3 in the Relay Harness.

NOTE: If the input wire H1/3 is not connected, there will be no output on this wire.

H1/5 GREEN/BLACK Lock #30 Common (Output)

The system has door lock relays on-board, and can directly interface with most electric power door lock systems drawing 30 amps or less. It can also drive aftermarket actuators directly. (Some vehicles require that an aftermarket actuator be added to the driver's door to allow system control, see Type D wiring section in Tech Tip Document 1041).

H1/6 WHITE/BLACK Lock #87 Normally Closed

See H1/5.

H1/7 VIOLET/BLACK Lock #87 Normally Opened (Input)

See H1/5.

H1/8 BLUE/BLACK Unlock #30 Common (Output)

See H1/5.

H1/9 VIOLET Unlock #87 Normally Open (Input)

See H1/5.

H1/10 WHITE (+/-) Parking Light Flash Output

This wire provides a high current + or - output to flash the parking lights (+ is factory default setting). This is suitable for driving (-) light control wires in Toyota, Lexus, BMW, some Mitsubishi, some Mazda, etc. If the vehicle has a negative parking light circuit, the light flash jumper on the control module must be moved.

H1/11 BLACK (-) Chassis Ground Connection

Connect this wire to a clean, paint-free sheet metal location (driver kick panel) using a factory bolt that DOES NOT have any vehicle component grounds attached to it. A screw should only be used when in conjunction with a two-sided lock washer. Under dash brackets and door sheet metal are not acceptable ground points. It is recommended that all security components be grounded at the same location.

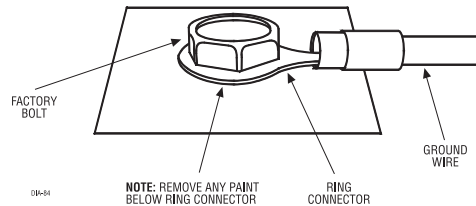

H1/12 BROWN (-) Horn Honk Output

This wire supplies a (-) 200 mA output that can be used to honk the vehicle horn. It outputs a single pulse when locking the doors with the remote, and two pulses when unlocking with the remote. This wire will also output pulses for 30 seconds when the Panic Mode is activated. If the vehicle has a (+) horn circuit, an optional relay can be used to interface with the system, as shown below.

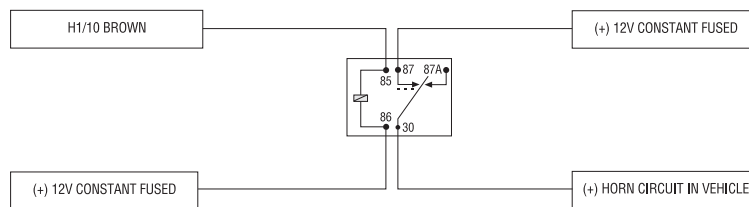

H1/13 LT. GREEN/BLACK Factory Alarm Disarm

This wire supplies a

H1/14 WHITE/BLUE (-) Channel 3 Output

This wire provides a (-) 200 mA output whenever the transmitter code controlling Channel 3 is received. This output will continue as long as that transmission is received. Use for options such as Directed's 551T Valet® Start system, 529T or 530T power window controllers, etc.

IMPORTANT! Never use this wire to drive anything but a relay or a low-current input! The transistorized output can only provide 200 mA of current, and connecting directly to a solenoid, motor, or other high-current device will cause it to fail.

H1/15 YELLOW (+) Switched Ignition Input

Connect this wire to an ignition source. This input must show (+)12V with the key in run position and during cranking. Make sure that this wire cannot be shorted to the chassis at any point. This wire will trigger the system if the ignition is turned on before the unit is disarmed (doors unlocked with the remote). It will also honk the vehicle's horn and flash the parking lights (if connected).

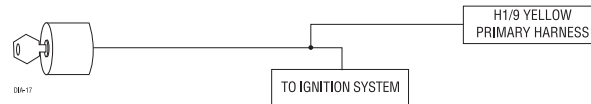

H1/16 ORANGE (-) 500mA Ground-When Armed Output

This wire supplies a (-) 500mA ground as long as the system is armed. This output ceases as soon as the system is disarmed.

Note: If using the H1/16 Orange wire to activate an add-on accessory such as window automation, pager or voice module a 1-Amp diode must be installed to ensure proper operation. Insert the diode as shown the the following diagram.

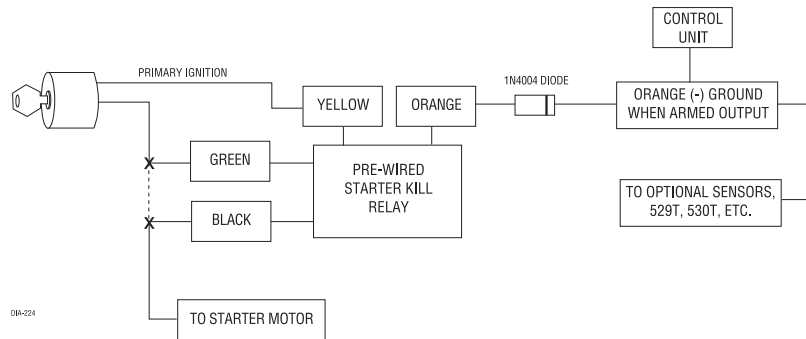

H1/17 BROWN/BLACK Unlock #87A Normally Closed

See H1/5.

H1/18 RED/WHITE channel 2, 200mA (-) output

When the system receives the transmitter code controlling Channel 2 for longer than 1.5 seconds, the red/white wire will supply an output as long as the transmission continues. This is often used to operate a trunk/hatch release or other relay-driven functions.

IMPORTANT! Never use this wire to drive anything but a relay or a low-current input! The transistorized output can only supply 200 mA of current. Connecting directly to a solenoid, motor, or other high-current device will cause it to fail.

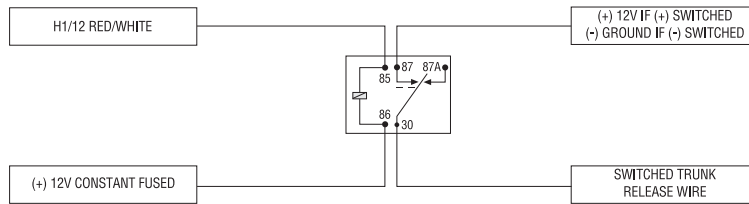

00-4

Peripheral Plug-In Harnesses

Super Bright LED, 2-Pin WHITE Plug

The super bright LED operates at (+) 2 volt DC and plugs into the two-pin WHITE port. Make sure the LED wires are not shorted to ground as the LED will be damaged. Multiple LED's can be used, but they must be wired in series. The LED fits into a 9/32-inch mounting hole. Be sure to check for clearance prior to drilling the mounting hole.

NOTE: Never use a BLUE LED in combination with a RED LED.

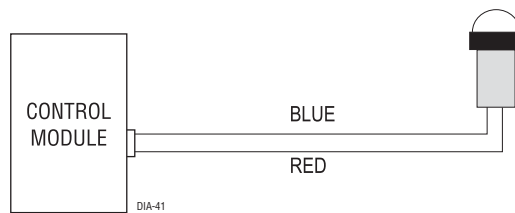

Valet/Program Switch, 2-Pin BLUE Plug

The Valet/Program button should be accessible from the driver's seat. It plugs into the BLUE port on the side of the unit. Consider how the button will be used before choosing a mounting location. Check for rear clearance before drilling a 9/32-inch hole and mounting the button.

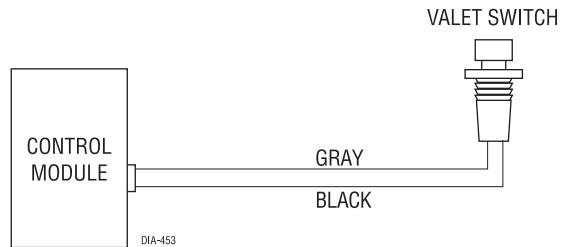

System Features Learn Routine

The System Features Learn Routine dictates how the unit operates. It is possible to access and change any of the feature settings using the Valet®/Program switch.

To enter the learn routine:



1. **Key.** Turn the ignition on and then back off.

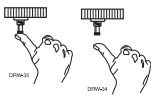

2. **Choose.** Within 10 seconds, press and release the Valet®/Program switch the number of times corresponding to the feature number you want to program. (See Feature Menus.) Once the Valet®/Program switch has been pressed and released the desired number of times, press it once more and hold it. After a second, the LED will flash and the horn will honk to indicate which feature you have accessed.



3. **Transmit.** The transmitter is used to select the desired setting. As shipped, the unit is configured to the LED ON settings. These are the default settings. Pressing the lock button will set it to the LED ON setting. The LED will light solid (stop flashing) to indicate the setting. The horn will honk once (if connected). Pressing the unlock button will change the setting to the LED OFF setting. The LED will go out indicating the change and the horn will honk twice (if connected).



4. Release. The Valet®/Program switch can now be released.

For example, to program the arming mode from active to passive, within 10 seconds of turning the ignition off, and press and release the Valet/Program switch once. Then press it again and hold it. The LED will flash in groups of one and the horn will honk once (if connected). While holding the Valet®/Program switch, press the unlock button. The LED will stop flashing and go out. The horn will honk twice if connected. Passive arming is now programmed. If that was not the desired setting, without releasing the Valet®/Program switch, press the lock button. The LED will light solid and the horn will honk once if connected. Active arming is now programmed. Release the Valet®/Program switch after the selection has been made.

You can advance from feature to feature by pressing and releasing the Valet®/Program switch the number of times necessary to get from the feature you just programmed to the feature you wish to access. For example, if you just programmed Feature 2 and you next want to program Feature 3 to off, release the Valet®/Program switch. Press and release it once to advance from Feature 2 to Feature 3. Then press it once more and hold it. The LED will flash in groups of three and the horn will honk three times (if connected) to confirm that you have accessed Feature 3.

The learn routine will be exited if:

- The ignition is turned on.
- The Valet/Program switch is pressed too many times.
- More than 15 seconds elapses between programming steps.

One long horn honk (if connected) indicates that the Learn Routine has been exited.

System Features Menus

Feature Number	Default LED ON Setting (Press Channel 1)	LED OFF Setting (Press Channel 2)
1	Ignition-controlled door lock ON	Ignition-controlled door lock OFF
2	Ignition-controlled door unlock ON	Ignition-controlled door unlock OFF
3	Ignition-controlled domelight ON	Ignition-controlled domelight OFF
4	0.8 second door lock pulses	3.5 second door lock pulses/0.4 sec.
5	Double pulse unlock OFF	Double pulse unlock ON
6	Double pulse lock OFF	Double pulse lock ON
7	Comfort closure OFF	Comfort closure ON
8	Code Hopping ON	Code Hopping OFF

Note: Factory default settings are shown in **BOLD**.

Note: For feature number 1-4, the 3.5 second door lock pulse setting the siren chirps twice, for the 0.4 second door lock pulse setting the siren chirps three times.

Feature Descriptions

The features of the system are described below.

1 IGNITION CONTROLLED DOOR LOCK ON/OFF: When turned on, the doors will lock three seconds after the ignition is turned on.

2 IGNITION CONTROLLED DOOR UNLOCK ON/OFF: When turned on, the doors will unlock when the ignition is turned off.

3 IGNITION CONTROLLED DOMELIGHT: If turned on, the system will turn on the domelight for 30 seconds when the ignition is turned off. The domelight supervision output (H1/4) wire must be connected to an optional relay as described in the Primary Harness Wire Connection Guide.

4 DOOR LOCK PULSE DURATION: Some European vehicles, such as Mercedes-Benz and Audi, require longer lock and unlock pulses to operate the vacuum pump. Programming the system to provide 3.5 second pulses will accommodate the door lock interface in these vehicles. The default

setting is 0.8 second door lock pulses. For some vehicles a 0.4 second pulse duration is required, this durations is required for some vehicles to prevent the windows from moving.

5 *DOUBLE PULSE UNLOCK OFF/ON*: Some vehicles require two pulses on a single wire to unlock the doors. When the double pulse unlock feature is turned on, the BLUE/BLACK H1/8 wire will supply two negative pulses instead of a single pulse.

6 *DOUBLE PULSE LOCK OFF/ON*. Selectable 2 pulse door lock output to operate vehicle equipped with factory “deadbolt”. Will have similar operation to that of the Double Pulse Unlock feature, but will perform the functions on the Lock wire as opposed to the Unlock wire.

7 *COMFORT CLOSURE FEATURE OFF/ON*: This feature is designed to integrate with vehicles that can close the power windows and sunroof by holding the key in the driver door lock position, and will operate on both single input systems and two pulses input dead bolt systems.

If programmed ON the door lock output will activate the Comfort Close output for 20 seconds. This output will begin 200mS after the final door lock output has completed regardless of the door lock programming.

If while the 20 second timer is active and closing the windows the user disarms the unit, the Comfort Close output will immediately cease before the doors unlock.

8 *CODE-HOPPING ON/OFF*: The system features Code-Hopping as an option.

Transmitter/Receiver Learn Routine

The system comes with two transmitters that have been taught to the receiver. The receiver can store up to four different transmitter codes in memory. Use the following learn routine to add transmitters to the system or to change button assignments if desired.



1. **Key.** Turn the key to the ON position.



2. **Choose.** Within 10 seconds, press and release the Valet/program switch the number of times corresponding to the desired channel listed below. Once you have selected the channel, press the switch once more and HOLD it. The LED will flash and the horn will honk (if connected) to confirm the selected channel. Do not release the Valet/program switch.



3. **Transmit.** While holding the Valet/Program button, press the button from the transmitter that you wish to assign to the selected channel. The unit will chirp indicating successful programming. It is not possible to teach a transmitter button to the system more than once.



4. **Release.** Once the code is learned, the Valet/Program button can be released.

Channel Number	Function	Wire Color
1	Auto Learn	
2	Arm only	
3	Disarm only	
4	Channel 2	RED/WHITE
5	Channel 3	WHITE/BLUE
6	Arm/Disarm/Panic	
7	Panic Only	
8	Delete all transmitters	

*NOTE: For Auto Learn Configurations, see *Transmitter Configurations* section of this guide.

Channel #8: If any button from a known transmitter is programmed to Channel 8, all transmitters will be erased from memory and the system features will revert to the default settings. This is useful in cases where the one of the customer's transmitters is lost or stolen. This will erase any lost or stolen transmitters from the system's memory. It can also be used to start from scratch if the transmitter buttons were programmed incorrectly.

To exit the learn routine:

One long horn honk indicates that Learn Routine has been exited.







- Ignition is turned off.
- Valet/Program button is pressed too many times.
- More than 15 seconds elapse between steps.

Transmitter Configurations

The transmitters can be programmed with the standard or single button arm/disarm configurations by using the Auto Learn functions in the Transmitter/Receiver Learn Routine.

Standard Configuration

A remote that uses the standard configuration operates similarly to many factory keyless entry remotes. A standard configuration transmitter allows arming, disarming, and Panic Mode activation with separate buttons. When programmed for standard configuration using the Channel 1 Auto-learn configuration, the transmitter buttons are assigned to the following functions:

	operates	Arm only
	operates	Disarm only
	operates	Channel 2 and Silent Mode
	operates	Panic only
 and 	operate	Channel 3

Rapid Resume Logic

Rapid Resume Logic ensures that when the system is powered up it will return to the same state it was in when power is disconnected. For a full description of Rapid Resume Logic refer to the owner's manual.

Wiring Quick Reference Guide

